

STANDARD BIDDING DOCUMENTS
For
Construction of Farmers Outlet at Gedu under
FSAPP Project



Royal Government of Bhutan
Ministry of Finance

2019

PREFACE

Procurement under projects financed by the Royal Government of Bhutan is carried out in accordance with policies and procedures laid down in the *Procurement Rules and Regulations*. The Standard Bidding Documents in this publication have been prepared for use by Employers in the Procurement of Works for Works Contracts above Nu.5 (five) Million. This document will come in effect from 1st July 2019.

To obtain further information on procurement you may contact:
Government Procurement and Property Management Division
Department of National Properties
Ministry of Finance

INVITATION FOR BIDS

Notes on the Invitation for Bids (IFB)

Its purpose is to supply information to enable potential Bidders to decide whether to participate in the procurement process. The Invitation for Bids shall specify any important Bid evaluation criteria (for example, the application of a margin of preference in Bid evaluation) and qualification requirements (for example, a requirement for a minimum level of experience in carrying out works of a similar type and size to those for which the IFB is issued).

The Invitation for Bids shall not be incorporated into the Bidding Documents. However, the information contained in the Invitation for Bids should conform to the Bidding Documents and in particular to the relevant information in the Bidding Data Sheet.

SAMPLE FORMAT FOR INVITATION FOR BIDS

Invitation for Bids (IFB)

Bhutan

CDA/DES-10/2019-2020/ 4608

Date: 9/1/2020

TENDER NOTIFICATION.

1. The Dzongkhag Administration, Chhukha invites bid from eligible and qualified bidders registered with CDB for the following works as follow.

SI.No.	Name of work	Contract duration (Months)	Date of sale of document	Submission date	Opening date & Time	Category
1	Construction of Farmers Outlet at Gedu under Chhukha Dzongkhag	10	10/1/2020	10/02/2020 at 9.30 am	10/02/2020 at 10:00 am	Medium

1. The documents can be downloaded from the Chhukha Dzongkhag web site www.chhukha.gov.bt and CDB web site www.cdb.gov.bt.
2. Bid must be submitted on above specified time and date by intending bidders failing the bids shall be rejected.
3. Bidders should be fully acquainted with the site before quoting the rates.
4. The bids shall be opened in the Dzongkhag Conference Hall in presence of bidder or their representatives who choose to attend in person.
5. Fronting of license shall not be entertained and none compliance to notification shall result taking action in accordance to the contract terms & conditions.
6. For further clarification, 08478813 may be contacted during working hour. The concerned site engineer also may be contacted upon referring in the contract documents.
7. Bidder should furnish valid postal address.
8. Decision of the Dzongkhag Level Tender Committee shall be **final and binding**.

(Chairperson)

Dzongkhag Tender Committee.

Copy to:

1. Dasho Dzongdag, CDA, for kind information.
2. Chairman, Tender Opening Committee, CDA, for information.
3. Chairman, Tender Evaluation Committee, CDA, for information.
4. CDAO/DPO, CDA, for information.
5. AFO, CDA, for information and with instruction to charge the advertisement payment from the respective works.
6. IT, CDA, for information and with request to support in uploading in appropriate web site, (www.chhukha.gov.bt and CDB web site www.cdb.gov.bt).
7. Mrs Sangay Pelden, , Site Engineers, CDA, for information & render support as and when bidder enquires about site/ clarification.

TABLE OF CONTENTS

Introduction	1
Section I. Instructions to Bidders (ITB)	2
Section II. Bidding Data Sheet	28
Section III. Eligible Countries	31
Section IV. Evaluation and Qualification Criteria.....	32
Section V. Bidding Forms	39
Section VI. General Conditions of Contract (GCC)	55
Section VII. Special Conditions of Contract	84
Section VIII Specifications and Performance Requirements.....	89
Section IX. Drawings.....	90
Section X. Contract Forms	91

INTRODUCTION

These Standard Bidding Documents are intended as a model for ad measurement (unit prices or unit rates in a Bill of Quantities) and lump sum types of Contract, which are the most common in Works contracting. Lump sum contracts are used in particular for buildings and other forms of construction where the Works are well defined and are unlikely to change in quantity or specifications, and where encountering difficult or unforeseen site conditions (for example, hidden foundation problems) is unlikely. The main text refers to ad measurement contracts. **Alternative clauses or texts are supplied for use with lump sum contracts.**⁸

Care should be taken to check the relevance of the provisions of the standard documents against the requirements of the specific Works to be procured. The following directions should be observed when using the documents:

- (a) All the documents listed in the Table of Contents are normally required for the procurement of Works. However, they should be adapted as necessary to the circumstances of the particular Project.
- (b) Before issuing these Bidding Documents the Employer shall prepare the Bidding Data Sheet (Section II), Special Conditions of Contract (Section VI), and Sections VII, VIII and IX which deal with Specifications and Performance Requirements, Drawings, and Bill of Quantities respectively. The Employer should read and/or provide the information specified in the italicized notes inside brackets. In the few instances where the Bidder is requested to provide information, the note specifies it. **The footnotes and notes for the Employer are not part of the text; they should not be incorporated in the Bidding Documents issued to the Bidders.**
- (c) These Bidding Documents are intended to serve on a repetitive basis. Modifications for specific Project or Contract needs should be provided only in the Bidding Data Sheet and the Special Conditions of Contract, as amendments to the Instructions to Bidders and the General Conditions of Contract respectively.
- (d) The notes inside unshaded boxes, as well as others intended as guidance for the Employer, are not part of the text, but rather contain instructions for the user, as do the Preface and this Introduction section. **They should not be incorporated in the Bidding Documents.** The cover (first) page should be modified as required to identify the Bidding Documents as to the names of the Project, Contract and Employer, in addition to date of issue.
- (e) The notes inside boxes with a shaded background should be retained in the issued Bidding Documents, since these provide important guidance to Bidders.
- (f) The standard documents have been prepared for bidding where post qualification applies. However, with relatively minor modifications they also can be used where prequalification applies. The process of prequalification of Bidders is not covered in these standard documents.

² Lump sum contracts should be used for Works that can be defined in their full physical and qualitative characteristics before bids are called, or where the risks of substantial design variations are minimal—usually construction of buildings, pipe laying, power transmission towers and series of small structures, such as bus shelters or school ablution units. In lump sum contracts, the concept of priced activity schedules has been introduced, to enable payments to be made as activities are completed. Payments can also be made on the basis of percentage completion of each activity.

SECTION I. INSTRUCTIONS TO BIDDERS (ITB)

Notes on the Instructions to Bidders

This section of the Bidding Documents should provide the information necessary for Bidders to prepare responsive Bids, in accordance with the requirements of the Employer. It should also give information on Bid submission, opening and evaluation, and on the award of Contract.

Matters governing the performance of the Contractor, payments under the Contract, or matters affecting the risks, rights and obligations of the parties under the Contract are not normally included in this Section, but rather under Section V, General Conditions of Contract and/or Section VI, Special Conditions of Contract. If duplication of a subject is inevitable in the different sections of the documents, care must be exercised to avoid contradictions between clauses dealing with the same matter.

These Instructions to Bidders shall not be part of the Contract and shall cease to have effect once the Contract is signed.

TABLE OF CONTENTS

A. General	5
1. Scope of Bid and Source of Funds.....	5
2. Fraud and Corruption.....	5
3. Eligible Bidders.....	7
4. One Bid per Bidder	9
5. Cost of Bidding	9
6. Site Visit	9
B. Bidding Documents.....	9
7. Content of Bidding Documents	9
8. Clarification of Bidding Documents	10
9. Amendment of Bidding Documents.....	10
C. Preparation of Bids.....	11
10. Language of Bid.....	11
11. Documents Comprising the Bid ²⁰	11
12. Bid Prices	12
13. Currencies of Bid and Payment	12
14. Bid Validity	13
15. Bid Security	13
16. Alternative Proposals by Bidders	15
17. Documents establishing Eligibility and Qualifications of the Bidder	15
18. Format and Signing of Bid	15
D. Submission of Bids	16
19. Sealing and Marking of Bids ²⁹	16
20. Deadline for Submission of Bids	17
21. Late Bids.....	17
22. Withdrawal, Substitution and Modification of Bids.....	17
E. Bid Opening and Evaluation	17
23. Bid Opening.....	17
24. Confidentiality	19
25. Clarification of Bids.....	19
26. Examination of Bids and Determination of Responsiveness.....	19
27. Correction of Errors	20
28. Currency for Bid Evaluation	20
29. Evaluation and Comparison of Bids	20
30. Qualifications of the Bidder	22
31. Abnormally Low Bids	22
32. Seriously unbalanced Bids or Front Loaded.....	23
33. Specialized Subcontractor	23
34. Preference for Domestic Bidders	23

F. Award of Contract..... 24

35. Award Criteria 24

36. Employer’s Right to Accept any Bid and to Reject any or all Bids..... 24

37. Letter of Intent to Award /Notification of Award and Signing of Contract 24

38. Debriefing by the Employer 25

39. Performance Security 26

40. Advance Payment and Security 26

41. Adjudicator..... 26

42. Complaint and Review 26

INSTRUCTIONS TO BIDDERS (ITB)

A. General

- | | |
|--|--|
| 1. Scope of Bid and Source of Funds | <p>1.1. The Employer as defined¹⁰ in Section II, Bidding Data Sheet (BDS), invites Bids for the construction of Works, as described in the BDS and Section VI, Special Conditions of Contract (SCC). The name and identification number of the Contract is provided in the BDS and the SCC.</p> <p>1.2. The successful Bidder will be expected to complete the Works by the Intended Completion Date specified in the Special Conditions of Contract.</p> <p>1.3. The Employer as defined in section II, Bidding Data Sheet (BDS) has received a budget from RGoB towards the cost of the Project defined in the BDS and intends to apply a part of the funds to cover eligible payments under the contract for this works.</p> |
| 2. Fraud and Corruption | <p>2.1. It is RGoB's policy to require that Employers, Bidders, Suppliers, Contractors and their Subcontractors observe the highest standards of ethics during the procurement and execution of contracts.¹¹ In pursuance of this policy, the RGoB:</p> <p>(a) defines, for the purposes of this provision, the terms set forth below as follows:</p> <p>(i) "corrupt practice"¹² is the offering, giving, receiving or soliciting, directly or indirectly, of anything of value¹³ to influence improperly the actions of another party;</p> <p>(ii) "fraudulent practice"¹⁴ is any intentional act or omission, including a misrepresentation, that knowingly or recklessly misleads, or attempts to mislead, a party to obtain a financial or other benefit or to avoid an obligation;</p> <p>(iii) "collusive practice"¹⁵ is an arrangement between two or more parties designed to achieve an improper purpose, including to influence improperly the actions of another party;</p> |

¹⁰ See also definitions in Section V, General Conditions of Contract (GCC).

¹¹ In this context, any action taken by a Bidder, Supplier, Contractor or a Subcontractor to influence the procurement process or contract execution for undue advantage is improper.

¹² "another party" refers to a public official acting in relation to the procurement process or contract execution. In this context, "public official" includes staff and employees of any organizations (including any institutions providing finance for the Works) taking or reviewing procurement decisions.

¹³ "anything of value" includes, but is not limited to, any gift, loan, fee, commission, valuable security or other asset or interest in an asset; any office, employment or contract; any payment, discharge or liquidation of any loan, obligation or other liability whatsoever, whether in whole or in part; any other services, favour or advantage, including protection from any penalty or disability incurred or apprehended or from any action or proceeding of a disciplinary or penal nature, whether or not already instituted and including the exercise or the forbearance from the exercise of any right or any official power or duty.

¹⁴ a "party" refers to a public official; the terms "benefit" and "obligation" relate to the procurement process or contract execution; and the "act or omission" is intended to influence the procurement process or contract execution.

¹⁵ "parties" refers to participants in the procurement process (including public officials) and an "improper purpose" includes attempting to establish bid prices at artificial, non competitive levels.

- Ⓚ “coercive practice”¹⁶ is impairing or harming, or threatening to impair or harm, directly or indirectly, any party or the property of the party to influence improperly the actions of a party;
- (i) “obstructive practice” is
- (bb) deliberately destroying, falsifying, altering or concealing of evidence material to the investigation or making false statements to investigators in order to materially impede any investigation into allegations of a corrupt, fraudulent, coercive or collusive practice; and/or threatening, harassing or intimidating any party to prevent it from disclosing its knowledge of matters relevant to the investigation or from pursuing the investigation; or
- (cc) acts intended to materially impede the exercise of the inspection and audit rights of the Employer or any organization or person appointed by the Employer and/or any relevant RGoB agency provided for under ITB Sub-Clause 2.1 (d) below.
- (b) will reject a proposal for award if it determines that the Bidder recommended for award has, directly or through an agent, engaged in corrupt, fraudulent, collusive, coercive or obstructive practices in competing for the contract in question.
- (c) will sanction a firm or individual, including declaring them ineligible, either indefinitely or for a stated period of time, to be awarded a contract if it at any time determines that they have, directly or through an agent, engaged in corrupt, fraudulent, collusive, coercive or obstructive practices in competing for, or in executing contract;
- (d) will have the right to require that a provision be included in Bidding Documents and in contracts, requiring Bidders, Suppliers, Contractors and their Subcontractors to permit the Employer, any organization or person appointed by the Employer and/or any relevant RGoB agency to inspect their accounts and records and other documents relating to the Bid submission and contract performance and to have them audited by auditors appointed by the Employer;
- (e) requires that Bidders, as a condition of admission to eligibility, execute and attach to their bids an Integrity Pact Statement in the form provided in Section IV, Bidding Forms. Failure to provide a duly executed Integrity Pact Statement shall result in disqualification of the Bid; and
- (f) will report any case of corrupt, fraudulent, collusive, coercive or obstructive practice to the relevant RGoB agencies, including but not limited to the Anti-Corruption Commission (ACC) of Bhutan, for necessary action in accordance with the statutes and provisions of the relevant agency.

¹⁶ a “party” refers to a participant in the procurement process or contract execution.

2.2. Furthermore, Bidders shall be aware of the provision stated in GCC Sub-Clause 60.1

3. Eligible Bidders

- 3.1. A Bidder may be a private entity, government-owned entity, subject to ITB sub-clause 3.4, or any combination of such entities in the form of a joint venture (JV) under an existing agreement or with the intent to enter into such an agreement supported by a letter of intent. In the case of a joint venture, all members shall be jointly and severally liable for the execution of the entire Contract in accordance with the Contract terms. The JV shall nominate a Representative who shall have the authority to conduct all business for and on behalf of any and all the members of the JV during the Bidding process and, in the event the JV is awarded the Contract, during contract execution. Unless specified **in the BDS**, there is no limit on the number of members in a JV.
- 3.2. A Bidder may have the nationality of any country, subject to the restrictions pursuant to ITB 3.7. A Bidder shall be deemed to have the nationality of a country if the Bidder is constituted, incorporated or registered in and operates in conformity with the provisions of the laws of that country, as evidenced by its articles of incorporation (or equivalent documents of constitution or association) and its registration documents, as the case may be. This criterion also shall apply to the determination of the nationality of proposed subcontractors or sub-consultants for any part of the Contract including related Services
- 3.3. A Bidder shall not have a conflict of interest. All Bidders found to have conflict of interest shall be disqualified. Bidders may be considered to have a conflict of interest with one or more parties in this bidding process, if:
- (a) they have at least one controlling partner in common; or
 - (b) they receive or have received any direct or indirect subsidy from either party; or
 - (c) they have the same authorized legal representative for purposes of this Bid; or
 - (d) they have a relationship with each other, directly or through common third parties, that puts them in a position to have access to information about or influence on the Bid of another Bidder, or influence the decisions of the Employer regarding this bidding process; or
 - (e) a Bidder participates in more than one Bid in this bidding process. Participation by a Bidder in more than one Bid shall result in the disqualification of all Bids in which such Bidder is involved. However, this does not limit the inclusion of the same subcontractor in more than one Bid; or

- (f) a Bidder or any of its affiliates participated as a consultant in the preparation of the design or technical specifications of the Works that are the subject of the Bid or in any other way provided consulting services in any aspect of the preparatory stages leading up to the issue of these Bidding Documents; or
 - (g) a Bidder or any of its affiliates has been hired (or is proposed to be hired) by the Employer as Project Manager for the Contract implementation; or
 - (h) a Bidder or any of its affiliates employs or otherwise engages a close relative of a civil servant who either is employed by the Employer or has an authority over the bidder or its affiliates or over the bid. For the purposes of this Sub-Clause a close relative is defined as immediate family which includes father, mother, brother, sister, spouse and own children.
- 3.4. A Bidder that is determined to be ineligible pursuant to any of the provisions of this Bidding Document shall not be eligible to be awarded a Contract.
- 3.5. Government-owned enterprises in Bhutan shall be eligible only if they can establish that they (i) are legally and financially autonomous, (ii) operate under commercial law, and (iii) are not a dependent agency of the Employer.
- 3.6. Bidders shall provide such evidence of their continued eligibility satisfactory to the Employer as the Employer shall reasonably request.
- 3.7. A firm shall be excluded if:
- (a) as a matter of law or official regulation, Bhutan prohibits commercial relations with the country in which the firm is constituted, incorporated or registered; or
 - (b) by an act of compliance with a decision of the United Nations Security Council taken under Chapter VII of the Charter of the United Nations, Bhutan prohibits any import of goods or contracting of Works or services from that country in which the firm is constituted, incorporated or registered or any payments to persons or entities in that country.
- 3.8. A Bidder shall also be excluded if:
- (a) he is insolvent or is in receivership or is a bankrupt or is in the process of being wound up, or has entered into an arrangement with his creditors; or
 - (b) his business affairs are being administered by a court, judicial officer or appointed liquidator; or
 - (c) he has suspended business or is in any analogous situation arising from similar procedures under the laws and regulations of his country of establishment; or

- (d) he has been found guilty of professional misconduct by a recognized tribunal or professional body; or
- (e) he has not fulfilled his obligations with regard to the payment of taxes, social security or other payments due in accordance with the laws of the country in which he is established or of the Kingdom of Bhutan; or
- (f) he is or has been guilty of serious misrepresentation in supplying information required for any prior registration with the Employer or the Construction Development Board of Bhutan; or
- (g) he has been convicted of fraud and/or corruption by a competent authority; or
- (h) he has not fulfilled his contractual obligations with the Employer in the past; or
- (i) he has been debarred from participation in public procurement by any competent authority as per law.

- 4. One Bid per Bidder** 4.1. Each Bidder shall submit only one Bid, either individually or as a partner in a JV/C/A. A Bidder who submits or participates in more than one Bid (other than as a subcontractor or in cases of alternatives that have been permitted or requested) shall cause all the proposals with the Bidder's participation to be disqualified.
- 5. Cost of Bidding** 5.1. The Bidder shall bear all costs associated with the preparation and submission of his Bid, and the Employer shall in no case be responsible or liable for those costs.
- 6. Site Visit** 6.1. The Bidder, at the Bidder's own responsibility and risk, is encouraged to visit and examine the Site of Works and its surroundings and obtain all information that may be necessary for preparing the Bid and entering into a contract for construction of the Works. The costs of visiting the Site shall be at the Bidder's own expense.

B. Bidding Documents

- 7. Content of Bidding Documents** 7.1. The set of Bidding Documents comprises the documents listed in the table below and addenda issued in accordance with ITB Clause 9:
- Section I: Instructions to Bidders
 - Section II: Bidding Data Sheet
 - Section III: Section III:Eligible Countries
 - Section IV: Evaluation and Qualification Criteria
 - Section V: Bidding Forms
 - Section VI :General Conditions of Contract
 - Section VII: Special Conditions of Contract
 - Section VIII: Specifications and Performance Requirements
 - Section IX:Drawings

Section X: Bill of Quantities¹⁷ - This (or the Activity Schedule in the case of lump sum Contracts) comprises a paper hard copy and an electronic copy on CD-ROM.

Section XI: Forms of Securities and Invitation for Bids

8. Clarification of Bidding Documents

- 8.1. A prospective Bidder requiring any clarification of the Bidding Documents may notify the Employer in writing, including by cable, facsimile, telex or electronic mail, at the Employer's address indicated in the BDS. The Employer shall respond to any request for clarification received earlier than fifteen (15) days¹⁸ prior to the deadline for submission of bids. Copies of the Employer's response shall be forwarded to all purchasers of the Bidding Documents, including a description of the inquiry, but without identifying its source. Should the clarification result in changes to the essential elements of the Bidding Documents, the Employer shall amend the Bidding Documents, following the procedure in ITB Clause 9 and ITB Sub-Clause 20.2.
- 8.2. The bidder or his official representative is invited to attend a pre-bid meeting, which will take place at the place and time stated in BDS.
- 8.3. The purpose of the meeting will be to clarify issues and to answer questions on any matter that may be raised at that stage.
- 8.4. The bidder is requested to submit any questions in writing or by facsimile or email to reach the Employer not later than one week before the meeting.
- 8.5. Minutes of the meeting, including the text of the questions raised (without identifying the source of inquiry) and the responses given will be transmitted without delay to all purchasers of the bidding documents. Any modification of the bidding documents listed in Sub-Clause 8.1 which may become necessary as a result of the pre-bid meeting shall be made by the Employer exclusively through the issue of an Addendum pursuant to Clause 9 and not through the minutes of the pre-bid meeting.
- 8.6. Non-attendance of the pre-bid meeting will not be a cause for disqualification of a bidder.

9. Amendment of Bidding Documents

- 9.1. Before the deadline for submission of Bids, the Employer may modify the Bidding Documents by issuing addenda.

¹⁷ In lump sum contracts, delete "Bill of Quantities" and replace with "Activity Schedule".

¹⁸ It may be necessary to extend the deadline for submission of bids if the Employer's response results in substantial changes to the Bidding Documents. See ITB Clause 9 below.

92. Any addendum thus issued shall be part of the Bidding Documents, shall be binding on all Bidders and shall be communicated in writing, including by cable, facsimile, telex or electronic mail, to all purchasers of the Bidding Documents.¹⁹ Prospective Bidders shall acknowledge receipt of each addendum in writing, including by electronic mail, to the Employer.
93. To give prospective Bidders reasonable time in which to take an addendum into account in preparing their Bids, the Employer shall extend, as necessary, the deadline for submission of Bids, in accordance with ITB Sub-Clause 20.2 below.

C. Preparation of Bids

- 10. Language of Bid** 10.1. All documents relating to the Bid shall be in the language specified in the BDS.
- 11. Documents Comprising the Bid²⁰** 11.1. The Bid submitted by the Bidder shall comprise the following:
- (a) The Bid form (in the format indicated in Section V);
 - (b) Bid Security in accordance with Clause 15;
 - (c) Priced Bill of Quantities²¹ - this must be submitted in paper form, signed by the duly authorized signatory of the Bidder, and also in electronic form, if required by the Employer;
 - (d) **Qualifications:** documentary evidence in accordance with ITB 17 establishing the Bidder's qualifications to perform the Contract if its Bid is accepted;
 - (e) Written confirmation authorizing the signatory of the Bid to commit the Bidder, in accordance with ITB sub-clause 18.2;
 - (f) Alternative offers where invited;
 - (g) any other documents specified in the BDS
- 11.2. In addition to the requirements under ITB 11.1, bids submitted by a Joint Venture, Consortium or Association (JV/C/A) of two or more firms as partners shall comply with the following requirements, unless otherwise stated in the BDS:
- (a) the bid shall include all the information listed in ITB Sub-Clause 17.2 above for each JV/C/A partner;
 - (b) the Bid shall be signed so as to be legally binding on all partners;
 - (c) all partners shall be jointly and severally liable for the execution of the Contract in accordance with the Contract terms;

¹⁹ It is therefore important that the Employer maintain a complete and accurate list of recipients of the Bidding Documents and their addresses.

²⁰ No bid will be rejected during the opening except on grounds of non signing of bid forms and insufficient bid security. Non submission of documents like trade license, CDB certificate along with the bid should not become rejecting criteria. The bidder should be given an opportunity to submit such documents during evaluation within a reasonable time specified by the evaluation committee. Any rejection due to non responsiveness should be done after preliminary examination of the bids.

²¹ In lump sum contracts, delete "priced Bill of Quantities" and replace with "priced Activity Schedule".

- (d) one of the partners shall be nominated as being in charge, authorized to incur liabilities, and receive instructions for and on behalf of any and all partners of the JV/C/A;
- (e) the execution of the entire Contract, including payment, shall be done exclusively with the partner in charge; and
- (f) a copy of the JV/C/A Agreement entered into by the partners shall be submitted with the Bid; or a Letter of Intent to execute a JV/C/A Agreement in the event of a successful Bid shall be signed by all partners and submitted with the Bid, together with a copy of the proposed Agreement.

12. Bid Prices

12.1. The Contract shall be for the whole Works, as described in ITB Sub-Clause 1.1, based on the priced Bill of Quantities submitted by the Bidder.

12.2. The Bidder shall fill in rates and prices for all items of the Works described in the Bill of Quantities.²² Items for which no rate or price is entered by the Bidder shall not be paid for by the Employer when executed and shall be deemed covered by the other rates and prices in the Bill of Quantities. Corrections, if any, shall be made by crossing out, initialing, dating and rewriting.

12.3. The Bidder shall quote its final all-inclusive net price, including all incidental costs, for carrying out the Contract. All duties, taxes and other levies payable by the Contractor under the Contract, or for any other cause, as of the date 30 days prior to the deadline for submission of Bids, shall be included in the rates, prices and total Bid price submitted by the Bidder.²³

12.4. The rates and prices²⁴ quoted by the Bidder shall be subject to adjustment during the performance of the Contract²⁵ if provided for in the BDS and the SCC and the provisions of GCC Clause 48 of the General Conditions of Contract. The Bidder shall submit with the Bid all the information required under the SCC and GCC Clause 48 of the General Conditions of Contract.

13. Currencies of Bid and Payment

13.1. The unit rates and prices²⁶ shall be quoted by the Bidder entirely in Ngultrum (Nu). Foreign currency requirements shall be indicated as a percentage of the Bid price (excluding provisional sums²⁷) and shall be payable at the option of the Bidder in up to three foreign currencies.

²² In lump sum contracts, delete "described in the Bill of Quantities" and replace with "described in the drawings and specifications and listed in the Activity Schedule".

²³ In lump sum contracts, delete "rates, prices, and".

²⁴ In lump sum contracts, delete "rates and prices" and replace with "lump sum price".

²⁵ For contracts with a duration of more than 18 months the price adjustment normally should be allowed

²⁶ In lump sum contracts, delete "unit rates and prices" and replace with "lump sum price".

²⁷ Provisional sums are monetary sums specified by the Employer in the Bill of Quantities, to be used at his discretion for nominated subcontractors and other specified purposes.

13.2. The rates of exchange to be used by the Bidder in arriving at the local currency equivalent and the percentage(s) mentioned in ITB Sub-Clause 13.1 above shall be the selling rates for similar transactions established by the authority specified in the BDS prevailing on the date 30 days prior to the latest deadline for submission of Bids. These exchange rates shall apply for all payments so that no exchange risk shall be borne by the Bidder. If the Bidder uses other rates of exchange, the provisions of ITB Clause 28.1 shall apply. In any case, payments shall be computed using the rates quoted in the Bid.

13.3. Bidders shall indicate details of their expected foreign currency requirements in the Bid.

13.4. Bidders may be required by the Employer to clarify their foreign currency requirements and to substantiate that the amounts included in the rates and prices²⁸, if required in the BDS, are reasonable and responsive to ITB Sub-Clause 13.1.

13.5. In case of International Procurement from countries other than India, the procuring agency may invite bids in convertible currencies. The bids shall however, be evaluated in accordance with Sub-Clause 13.2 above, but the payment shall be made in the currency of bid.

14. Bid Validity

14.1. Bids shall remain valid for the period specified in the BDS.

14.2. In exceptional circumstances, the Employer may request that the Bidders extend the period of validity for a specified additional period. The request and the Bidders' responses shall be made in writing or by electronic mail. The Bid Security required pursuant to ITB Clause 15 shall be extended to 30 days after the deadline of the extended Bid validity period. A Bidder may refuse the request without forfeiting the Bid Security. The refusal to extend the bid by the bidder will make the bid invalid and shall not be further considered for evaluation and award, A Bidder agreeing to the request shall not be required or permitted to modify its Bid, except as provided for in ITB Clause 15.

14.3. In the case of contracts in which the Contract Price is fixed (not subject to price adjustment), if the period of Bid validity is extended beyond 60 days, the amounts payable in local and foreign currency to the Bidder selected for award shall be adjusted as specified in the request for extension. Bid evaluation shall be based on the Bid Price without taking the above correction into consideration.

15. Bid Security

15.1. The Bidder shall furnish, as part of the Bid, a Bid Security as specified in the BDS.

²⁸ For lump sum contracts, delete "rates and prices" and replace with "Lump Sum".

15.2. The Bid Security shall be in fixed amount as specified in BDS and denominated in Ngultrum (Nu) or the currency of the Bid or in another freely convertible currency, and shall:

- (a) at the Bidder's option, be in any of the following forms:
 - (i) a demand unconditional bank guarantee; or
 - (ii) a account payee demand draft; or
 - (iii) a account payee cash warrant.
- (b) be issued by a financial institution in Bhutan acceptable to the Employer & selected by the Bidder.
- (c) in the case of a bank guarantee, be substantially in accordance with the form of Bid Security included in Section X, Security Forms, or other form approved by the Employer prior to Bid submission;
- (d) be payable promptly upon written demand by the Employer in case the conditions listed in ITB Sub-Clause 15.5 are invoked;
- (e) be submitted in its original form; copies shall not be accepted;
- (f) remain valid for a period of 30 days beyond the validity period of the Bids, as extended, if applicable, in accordance with ITB Sub-Clause 14.2.

15.3. Any Bid not accompanied by a responsive Bid Security shall be Rejected by the Employer as non-responsive.

15.4. The Bid Securities of unsuccessful Bidders shall be returned as promptly as possible upon the successful Bidder furnishing the Performance Security and in any event not later than 30 days after the expiration of the validity of the unsuccessful Bidder's Bid.

15.5. The Bid Security may be forfeited

- (a) if a Bidder withdraws its Bid during the period of Bid validity specified by the Bidder on the Bid Submission Sheet, except as provided for in ITB Sub-Clause 14.2; or
- (b) if the Bidder that submitted the lowest evaluated Bid does not accept the correction of the Bid price pursuant to Clause 27; or
- (c) if the successful Bidder fails within the specified time limit to
 - (i) sign the Contract; or
 - (ii) furnish the required Performance Security

15.6. The Bid Security of a JV/C/A must be in the name of the JV/C/A that submits the Bid. If the JV/C/A has not been legally constituted at the time of bidding, the Bid Security shall be in the names of all future partners as named in the letter of intent.

-
- 16. Alternative Proposals by Bidders**
- 16.1. Alternatives shall not be considered, unless specifically allowed in the BDS. If so allowed, ITB Sub-Clauses 16.1 and 16.2 shall govern, and the BDS shall specify which of the following options shall be allowed:
- (a) Option One. A Bidder may submit alternative Bids with the base Bid and the Employer shall only consider the alternative Bids offered by the Bidder whose Bid for the base case was determined to be the lowest-evaluated Bid, or
 - (b) Option Two. A Bidder may submit an alternative Bid with or without a Bid for the base case. All Bids received for the base case, as well as alternative Bids meeting the Technical Specifications and Performance Requirements pursuant to Section VII, shall be evaluated on their own merits.
- 16.2. Alternative Bids shall provide all information necessary for a complete evaluation of the alternative by the Employer, including design calculations, technical specifications, breakdown of prices, proposed construction methods and other relevant details.
- 17. Documents establishing Eligibility and Qualifications of the Bidder**
- 17.1. To establish Bidder's eligibility in accordance with ITB 3, Bidders shall complete the Letter of Bid, included in Section V, Bidding Forms.
- 17.2. In accordance with Section IV, Evaluation and Qualification Criteria, to establish its qualifications to perform the Contract, the Bidder shall provide the information requested in the corresponding information sheets included in Section V, Bidding Forms.
- 17.3. If a margin of preference applies as specified in accordance with ITB 34, domestic Bidders, individually or in joint ventures, applying for eligibility for domestic preference shall supply all information required to satisfy the criteria for eligibility specified in accordance with ITB 34.
- 18. Format and Signing of Bid**
- 18.1. The Bidder shall prepare one original of the documents comprising the bid as described in ITB Clause 11, bound with the volume containing the Form of Bid, and clearly marked "ORIGINAL." In addition, the Bidder shall submit copies of the Bid, in the number specified in the BDS, and clearly marked as "COPIES." In the event of any discrepancy between the original and any copies, or between the original paper form of the Bill of Quantities (or Activity Schedule in the case of lump sum Contracts) and the electronic version, the original shall prevail.
- 18.2. The original and all copies of the Bid shall be typed or written in indelible ink and shall be signed by a person or persons duly authorized to sign on behalf of the Bidder, pursuant to ITB Sub-Clause 17.1. Unsigned Form of Bid & BOQ shall make the bid non-responsive. All pages of the Bid where entries or amendments have been made shall be initialed by the person or persons signing the Bid.

18.3. The Bid shall contain no alterations or additions, except those to comply with instructions issued by the Employer, or as necessary to correct errors made by the Bidder, in which case such corrections shall be initialed by the person or persons signing the Bid.

18.4. The Bidder shall furnish information as described in the Form of Bid on commissions or gratuities, if any, paid or to be paid to agents relating to this Bid, and to contract execution if the Bidder is awarded the contract.

D. Submission of Bids

19. Sealing and Marking of Bids²⁹

19.1. Bidders may always submit their Bids by mail or by hand. When so specified in the BDS, Bidders shall have the option of submitting their Bids electronically. Bidders submitting Bids electronically shall follow the procedures specified in the BDS. The bidder shall seal the original and all copies of the Bid, including alternative bids if permitted in accordance with ITB Clause 16, in separate inner envelopes contained within one outer envelope. All envelopes shall be sealed with adhesive or other sealant to prevent reopening.

19.2. The inner envelopes shall

- (a) be signed across their seals by the person authorized to sign the bid on behalf of the bidder; and
- (b) be marked "ORIGINAL", "ALTERNATIVE" (if any) and "COPIES";

19.3. The outer envelope shall:

- (a) be sealed with adhesive or other sealant to prevent reopening,
- (b) be marked "Confidential";
- (c) be addressed to the Employer at the address³⁰ provided in the BDS;
- (d) bear the name and identification number of the Contract as defined in the BDS and SCC; and
- (e) provide a warning not to open before the specified time and date for bid opening as defined in the BDS.

19.4. In addition to the identification required in ITB Sub-Clause 19.2, the inner envelopes shall indicate the name and address of the bidder to enable the bid to be returned unopened in case it is declared late pursuant to ITB Clause 21.

19.5. If the outer envelope is not sealed and marked as above, the Employer shall assume no responsibility for the misplacement or premature opening of the Bid.

²⁹ Improper marking & sealing of the document cannot result in the rejection of bids

³⁰ The receiving address shall be an office that is staffed during normal working hours by personnel authorized to certify time and date of receipt and assure safe-keeping until Bid opening. A post office address is not to be used. The address must be the same as the receiving address described in the Invitation for Bids.

-
- 20. Deadline for Submission of Bids**
- 20.1. Bids shall be delivered to the Employer at the address specified above no later than the time and date specified in the BDS.
- 20.2. The Employer may extend the deadline for submission of bids by issuing an amendment in accordance with ITB Clause 9, in which case all rights and obligations of the Employer and the bidders previously subject to the original deadline shall then be subject to the new deadline.
- 21. Late Bids**
- 21.1. Any bid received by the Employer after the deadline prescribed in ITB Clause 20 shall be returned unopened to the bidder.
- 22. Withdrawal, Substitution and Modification of Bids**
- 22.1. Bidders may withdraw, substitute or modify their bids by giving notice in writing before the deadline prescribed in ITB Clause 20.
- 22.2. Each bidder's withdrawal, substitution or modification notice shall be prepared, sealed, marked and delivered in accordance with ITB Clauses 18 and 19, with the outer and inner envelopes additionally marked "WITHDRAWAL", "SUBSTITUTION" or "MODIFICATION" as appropriate.
- 22.3. No bid may be substituted or modified after the deadline for submission of bids.
- 22.4. Withdrawal of a bid between the deadline for submission of Bids and the expiration of the period of bid validity specified in the BDS or as extended pursuant to ITB Sub-Clause 14.2 may result in the forfeiture of the bid security pursuant to ITB Clause 15. If the lowest or the lowest evaluated bidder withdraws his bid between the periods specified pursuant to clause 22.4, the bid security of the bidder shall be forfeited and in addition the bidder shall pay to the Employer the positive difference of sum, if any with the next lowest bidder within 14 days of his withdrawal. If the bidder fails to pay the difference within the said date, the bidder shall be debarred by a Competent Authority as per law.
- 22.5. Bidders may only offer discounts to, or otherwise modify the prices of their bids, by submitting bid modifications in accordance with this clause or included in the initial bid submission.
- E. Bid Opening and Evaluation**
- 23. Bid Opening**
- 23.1. The Employer shall open the Bids, including modifications made pursuant to ITB Clause 22, in the presence of the bidders' representatives who choose to attend at the time and in the place specified in the BDS. Any specific opening procedures required if electronic bidding is permitted in accordance with ITB Sub-Clause 20.1 shall be as specified in the BDS.
- 23.2. Envelopes marked "WITHDRAWAL" shall be opened and read out first. Bids for which an acceptable notice of withdrawal has been submitted pursuant to ITB Clause 22 shall not be opened.

23.3. The Original & Copies will be opened at the bid opening. The bidders' names, the bid prices, the total amount of each bid and of any alternative bid (if alternatives have been requested or permitted), any discounts, Bid withdrawals, substitutions or modifications, the presence or absence of Bid Security (and any other details the Employer may consider appropriate) responses to any bidding documents addenda; fulfillment of any such other specific formal requirements as are prescribed in the bidding documents; and such other details as the Employer may consider appropriate, shall be announced by the Employer at the opening. This information also shall be written on a notice board for the public to copy. Any bid price, discount or alternative bid price not announced and recorded shall not be taken into account in bid evaluation.

The bid form including appendices to bid form, bill of quantities, price schedules, bid securities, any discounts offered, and any other important documents shall be initialed by all members of the Bid Opening Committee. All corrections/overwriting will be noted and recorded on each page of the Bill of Quantities. The bid evaluation will be done using the Copies while the Original will be kept in safe custody. If there are any discrepancies between the Original & Copies, the Original shall prevail.

No bid shall be rejected at bid opening except for late bids pursuant to ITB Clause 21. Substitution Bids and modifications submitted pursuant to ITB Clause 22 that are not opened and read out at Bid opening shall not be considered for further evaluation regardless of the circumstances. Late, withdrawn and substituted Bids shall be returned unopened to Bidders.

23.4. The Employer shall prepare Minutes of the bid opening, including the information disclosed to those present in accordance with ITB Sub-Clause 23.3. The Minutes shall include, as a minimum:

- (a) the Contract title and reference number;
- (b) the Bid number;
- (c) the Bid deadline date and time;
- (d) the date, time and place of Bid opening;
- (e) Bid prices, per lot if applicable, offered by the Bidders, including any discounts and alternative offers;
- (f) the presence or absence of Bid security and, if present, its amount and validity;
- (g) name and nationality of each Bidder, and whether there is a withdrawal, substitution or modification;
- (h) the names of attendees at the Bid opening, and of the Bidders they represent (if any);
- (i) details of any complaints or other comments made by attendees/representatives attending the Bid opening, including the names and signatures of the attendees/representatives making the complaint(s) and/or comment(s); and

- (j) the names, designations and signatures of the members of the Bid Opening Committee.

The Bidders' representatives and attendees who are present shall be requested to sign the record. The omission of a Bidder's or other attendee's signature on the record shall not invalidate the contents and effect of the record. A copy of the record shall be distributed to all Bidders.

24. Confidentiality

- 24.1. Information relating to the examination, clarification, evaluation and comparison of bids and recommendations for the award of a contract shall not be disclosed to bidders or any other persons not officially concerned with such process until publication of the award to the successful bidder has been announced pursuant to ITB Sub-Clause 37. Any effort by a bidder to influence the Employer's processing of bids or award decisions may result in the rejection of his bid. Notwithstanding the above, from the time of bid opening to the time of Contract award, if any bidder wishes to contact the Employer on any matter related to the bidding process, it should do so in writing, including by electronic mail.

25. Clarification of Bids

- 25.1. To assist in the examination, evaluation and comparison of bids, the Employer may, at the Employer's discretion, ask any bidder for clarification of the bidder's bid, including breakdowns of unit rates.³¹ The request for clarification and the response shall be in writing, including by electronic mail, but no change in the price or substance of the bid shall be sought, offered or permitted except as required to confirm the correction of arithmetic errors discovered by the Employer in the evaluation of the bids in accordance with ITB Clause 27.

26. Examination of Bids and Determination of Responsiveness

- 26.1. Prior to the detailed evaluation of bids, the Employer shall determine whether each bid (a) meets the eligibility criteria defined in ITB Clause 3; (b) has been properly signed; (c) is accompanied by the Bid Security; and (d) is substantially responsive to the requirements of the bidding documents.
- 26.2. A substantially responsive bid is one which conforms to all the terms, conditions and specifications of the bidding documents, without material deviation or reservation. A material deviation or reservation is one (a) which affects in any substantial way the scope, quality or performance of the Works; (b) which limits in any substantial way, inconsistent with the Bidding Documents, the Employer's rights or the Bidder's obligations under the Contract; or (c) whose rectification would affect unfairly the competitive position of other Bidders presenting substantially responsive Bids.

³¹ In lump sum contracts, delete "unit rates" and replace with "the prices in the Activity Schedule".

- 26.3. If a Bid is not substantially responsive, it will be rejected by the Employer, and may not subsequently be made responsive by correction or withdrawal of the nonconforming deviation or reservation.
- 27. Correction of Errors**
- 27.1. Bids determined to be substantially responsive shall be checked by the Employer for any arithmetic errors. Errors shall be corrected by the Employer as follows:³²
- (a) where there is a discrepancy between the amounts in figures and in words, the amount in words shall govern; and
 - (b) where there is a discrepancy between the unit rate and the line item total resulting from multiplying the unit rate by the quantity, the unit rate as quoted shall govern, unless in the opinion of the Employer there is an obviously gross misplacement of the decimal point in the unit rate, in which case the line item total as quoted shall govern, and the unit rate shall be corrected.
- 27.2. The corrections will be notified in writing to the individual bidder with a request for written acceptance of the corrections within the specified period as made in the notification. The amount stated in the Bid shall be adjusted by the Employer in accordance with the above procedure for the correction of errors and, with the concurrence of the Bidder, shall be considered as binding upon the Bidder. If the Bidder does not accept the corrected amount, the Bid shall be rejected, and the Bid Security may be forfeited in accordance with ITB Sub-Clause 15.5 (b).
- 28. Currency for Bid Evaluation**
- 28.1. Bids shall be evaluated as quoted in Ngultrum (Nu) in accordance with ITB Sub-Clause 13.1, unless a Bidder has used different exchange rates than those prescribed in ITB Sub-Clause 13.2, in which case the Bid shall be first converted into the amounts payable in different currencies using the rates quoted in the Bid and then reconverted to Ngultrum (Nu) using the exchange rates prescribed in ITB Sub-Clause 13.2.
- 29. Evaluation and Comparison of Bids**
- 29.1. The Employer shall evaluate and compare only the bids determined to be substantially responsive in accordance with ITB Clause 26.
- 29.2. In evaluating the bids, the Employer shall determine for each bid the evaluated bid price by adjusting the bid price as follows:
- (a) making any correction for errors pursuant to ITB Clause 27;

³² In lump sum contracts, delete from "as follows" to the end, and replace with the following: "as follows: where there is a discrepancy between the amounts in figures and in words, the amount in words shall govern."

- (b) excluding provisional sums and the provision (unless no rates have been asked from the bidders), if any, for contingencies in the Bill of Quantities,³³ but including Daywork,³⁴ where priced competitively;
- (c) making an appropriate adjustment for any other acceptable variations, deviations or alternative offers submitted in accordance with ITB Clause 16; and
- (d) making appropriate adjustments to reflect discounts or other price modifications offered in accordance with ITB Sub-Clause 22.5.

29.3. The bids shall be evaluated by applying the evaluation criteria, sub criteria and points system specified in Section IV, Evaluation and Qualification Criteria. Each responsive bid will be given a technical score. Financial bids of only those bidders who score the minimum technical score specified in Section IV, Evaluation and Qualification Criteria will be considered for the second stage of bid evaluation to obtain an overall price preference -financial score. Work will be awarded to the bidder obtaining the highest overall price preference -financial score which will be obtained using the following formula:

$90\% \times (\text{Lowest quoted bid among qualifying tenders/ financial bid quoted by } x) + 10\% \times \text{Price preference score for } x.$

29.4. In the case of joint ventures, the individual credentials of the joint venture partners need to be averaged using their stake in the JV for the purpose of evaluation under the parameters of Similar work experience, performance score from previous work, Bid capacity and credit line available. For the parameters of equipment, manpower, Status, Employment of Bhutanese, the resources or information committed / provided by the JV as a single entity will be considered for award of points.

29.5. The Employer reserves the right to accept or reject any variation, deviation or alternative offer. Variations, deviations and alternative offers and other factors which are in excess of the requirements of the bidding documents or otherwise result in unsolicited benefits for the Employer shall not be taken into account in bid evaluation.

29.6. The estimated effect of any price adjustment conditions under GCC Clause 47, during the period of implementation of the Contract, shall not be taken into account in bid evaluation.

³³ In lump sum contracts, delete "Bill of Quantities" and replace with "Activity Schedule".

³⁴ Daywork is work carried out following instructions of the Employer and paid for on the basis of time spent by workers, and the use of materials and the Contractor's equipment, at the rates quoted in the Bid. For Daywork to be priced competitively for Bid evaluation purposes, the Employer must list tentative quantities for individual items to be costed against Daywork (e.g., a specific number of tractor driver staff-days, or a specific tonnage of Portland cement), to be multiplied by the bidders' quoted rates and included in the total Bid price.

29.7. Domestic bidders and joint ventures, consortia or associations of domestic bidders who may be eligible for a margin of preference in bid evaluation shall supply all information to satisfy the criteria for eligibility as described in ITB Clause 3 of these Instructions to Bidders.

30. Qualifications of the Bidder

30.1. The Employer shall determine to its satisfaction whether the eligible Bidder that is selected as having submitted the lowest evaluated cost and substantially responsive Bid meets the qualifying criteria specified in Section IV, Evaluation and Qualification Criteria.

30.2. The determination shall be based upon an examination of the documentary evidence of the bidder's qualifications submitted by the bidder, pursuant to ITB 17. The determination shall not take into consideration the qualifications of other firms such as the bidder's subsidiaries, parent entities, affiliates, subcontractors (other than Specialized Subcontractors if permitted in the bidding document), or any other firm(s) different from the bidder.

31. Abnormally Low Bids

31.1. An Abnormally Low Bid is one where the bid price, in combination with other constituent elements of the bid, appears unreasonably low to the extent that the Bid price raises material concerns as to the capability of the bidder to perform the Contract for the offered bid price. Before proceeding to further analysis, the Employer shall revisit their departmental estimate to ensure its realistic compared to the prevailing market rates

31.2. Any bid price less than twenty percent (20%) from the employer's departmental estimate shall be scrutinized by seeking written clarifications from the Bidder, including detailed price analyses of its Bid price in relation to the subject matter of the contract, scope, proposed methodology, schedule, allocation of risks and responsibilities, and any other requirements of the request for bidding document.

31.3. After evaluation of the price analyses, in the event that the Employer determines that the Bidder has failed to demonstrate its capability to perform the Contract for the offered Bid Price, the Employer shall reject the Bid.

31.4. If the Procuring Agency decides to accept the abnormally low bid after considering the detailed price analysis, the Procuring Agency shall increase the performance security from ten percent (10%) up to maximum of 30% of the initial contract price; or

Alternatively, the procuring agency may ask the successful bidder to deposit the difference between departmental estimate and contract amount in the form of cash warrant in addition to 10% performance security. However, the total performance security amount shall be limited to maximum of 30% of initial contract price.

32. Seriously unbalanced Bids or Front Loaded

32.1. If the Bid that is evaluated as the lowest evaluated cost is, in the Employer's opinion, seriously unbalanced or front loaded the Employer may require the Bidder to provide written clarifications. Clarifications may include detailed price analyses to demonstrate the consistency of the Bid prices with the scope of works, proposed methodology, schedule and any other requirements of the bidding document.

32.2. After the evaluation of the information and detailed price analyses presented by the Bidder, the Employer may as appropriate:

- (a) accept the Bid and increase the performance security from ten percent (10%) up to maximum of 30% of the initial contract price; or
Alternatively, the procuring agency may ask the successful bidder to deposit the difference between departmental estimate and contract amount in the form of cash warrant in addition to 10% performance security. However, the total performance security amount shall be limited to maximum of 30% of initial contract price ; or
- (b) reject the Bid.

33. Specialized Subcontractor

33.1. Unless otherwise stated in the BDS, the Employer does not intend to execute any specific elements of the Works by specialized subcontractors selected in advance by the Employer. If permitted, Bidders may propose subcontracting up to the percentage of total value of contracts or the volume of works as specified in the BDS.

33.2. Specialized Subcontractors proposed by the Bidder shall be approved by the Employer only if registered in the specialized trade of CDB for the specific parts of the Works.

33.3. However, sub-contracting up to twenty percent (20%) of the initial contract price shall not require prior approval of employer but the sub-contractors should be registered in the specialized trade/contractors of CDB.

34. Preference for Domestic Bidders

34.1. As indicated in the BDS, domestic contractors may receive a margin of preference in Bid evaluation, for which this clause shall apply.

34.2. A domestic Bidder shall provide all evidence necessary to prove that it meets the following criteria to be eligible for a margin of preference in the comparison of its Bid with those of Bidders who do not qualify for the preference. A domestic Bidder shall:

- (a) be registered within Bhutan, constituted under and governed by the civil, commercial or public law of Bhutan, and have its statutory office, central administration or principal place of business there;

- (b) have majority ownership by nationals of Bhutan;
- (c) not subcontract more than twenty percent (20%) of the initial Contract Price, excluding provisional sums, to foreign contractors, suppliers and/or consultants.

34.3. Joint Ventures, Consortia and Associations of domestic firms may be eligible for the margin of preference provided that:

- (a) the individual partners satisfy the criteria of eligibility of ITB Sub-Clauses 34.2 (a) and (b);
- (b) the JV/C/A is registered in Bhutan;
- (c) the JV/C/A does not subcontract more than ten percent (10%) of the initial Contract Price, excluding provisional sums, to foreign firms; and
- (d) the JV/C/A satisfies any other criteria specified for the purpose of domestic preference eligibility, as specified in the BDS.

34.4. The procedure used to apply the margin of preference shall be as stipulated in the BDS.

F. Award of Contract

35. Award Criteria

35.1. Subject to ITB Clause 36, the Employer shall award the Contract to the Bidder whose Bid has been determined to be substantially responsive to the Bidding Documents and who has scored the highest in the price preference – financial score of 100, provided that such Bidder has been determined to be (a) eligible in accordance with the provisions of ITB Clause 3, (b) qualified in accordance with the provisions of ITB Clause 30 (Qualification of Bidder), and (c) fulfillment of works in-hand ceiling prescribed by CDB.

36. Employer's Right to Accept any Bid and to Reject any or all Bids

36.1. Notwithstanding ITB Clause 35, the Employer reserves the right to accept or reject any Bid, and to cancel the bidding process and reject all Bids, at any time prior to the award of Contract, without thereby incurring any liability to the affected Bidder or Bidders or any obligation to inform the affected Bidder or Bidders of the grounds for the Employer's action.³⁵

37. Letter of Intent to Award / Notification of Award and Signing of Contract

37.1. The Employer shall notify the concerned Bidder whose bid has been selected in accordance with ITB 35.1 in writing (using the format in section V-hereafter called the "Letter of Intent to Award") that the Employer has intention to accept its bid and the copy of this information shall be given to all other bidders who submitted the bid. Such notification should be communicated in writing, including by cable, facsimile, telex or electronic mail to all the bidders on the same day of dispatch. The Employer shall ensure that the same information is uploaded on their website on the same day of dispatch.

³⁵ Employers should not reject bids or annul bidding processes, except as permitted in the Procurement Rule and these Bidding Documents.

- 37.2. If no bidder submits complaint pursuant to ITB 42 within a period of ten (10) days of the notice provided under ITB 37.1, the bidder who's Bid has been accepted shall be notified in writing of the award by the Employer prior to expiration of the Bid validity period. This notification letter (hereinafter and in the General Conditions of Contract called the "Letter of Acceptance") shall state the sum that the Employer shall pay the Contractor in consideration of the execution, completion and maintenance of the Works by the Contractor as prescribed by the Contract (hereinafter and in the Contract called the "Contract Price").
- 37.3. The Letter of Acceptance shall constitute the formation of the Contract, subject to the Bidder furnishing the Performance Security in accordance with ITB Clause 39 and signing the Contract in accordance with ITB Sub-Clause 37.3. It shall be accompanied by two originals of the Contract in the form provided in Section V – Forms of Bid, Qualification Information, Letter of Acceptance, and Contract.
- 37.4. The Contract shall incorporate all agreements between the Employer and the successful Bidder. It shall be signed by the Employer and sent to the successful Bidder with the Letter of Acceptance. Within 15 days of receipt, the successful Bidder shall sign the Contract and deliver it to the Employer.
- 37.5. Upon the furnishing by the successful Bidder of the Performance Security, the Employer shall notify all other Bidders of the results of the bidding and shall publish a notification of award on the Employer's website. The notifications to all other Bidders as well as the notification posted on the Employer's website shall include the following information:
- (i) the Bid and lot numbers
 - (ii) name of the winning Bidder, and the Price it offered, as well as the duration and summary scope of the contract awarded; and
 - (iii) the date of the award decision.

38. Debriefing by the Employer

- 38.1. On receipt of the Employer's Notification of Intention to Award referred to in ITB 37.1, an unsuccessful bidder has three (3) working days to make a written request to the Employer for a debriefing. The Employer shall provide a debriefing to all unsuccessful bidders whose request is received within this deadline.
- 38.2. Where a request for debriefing is received within the deadline, the Employer shall provide a debriefing within five (5) working days.
- 38.3. The Employer shall discuss only such Bid and not the bids of other competitors. The debriefing shall not include:
- (a) point-by-point comparisons with another Bid; and

(b) information that is confidential or commercially sensitive to other Bidders.

38.4. The Purpose of debriefing is to inform the aggrieved bidder of the reasons for lack of success, pointing out the specific shortcomings in its bid without disclosing contents of other bids.

39. Performance Security

39.1. Within fifteen (15) working days after receipt of the Letter of Acceptance the successful Bidder shall deliver to the Employer a Performance Security in the amount stipulated in the GCC and in the form stipulated in the BDS, denominated in the type and proportions of currencies in the Letter of Acceptance and in accordance with the GCC.

39.2. If the Performance Security is provided by the successful Bidder in the form of a Bank Guarantee, it shall be issued, at the Bidder's option, by a financial institution located in Bhutan.

39.3. Failure of the successful Bidder to comply with the requirements of ITB Sub-Clauses 37.3 and 39.1 shall constitute sufficient grounds for cancellation of the award and forfeiture of the Bid Security. If the lowest evaluated bidder fails to produce the performance guarantee & sign the contract then apart from forfeiture of Bid Security, the bidder will also be required to bear the positive difference in contract amount between his bid and the bidder to whom the work has been awarded.

39.4. Upon the successful Bidder's signing of the Contract and furnishing of the Performance Security pursuant to ITB Sub-Clause 39.1, the Employer shall promptly notify the name of the winning Bidder to each unsuccessful Bidder in accordance with ITB Sub-Clause 37.4 and shall discharge the Bid Securities of the unsuccessful Bidders pursuant to ITB Sub-Clause 15.4.

40. Advance Payment and Security

40.1. The Employer shall provide an Advance Payment on the Contract Price as stipulated in the GCC, subject to a maximum amount, as stated in the BDS. The advance payment shall be guaranteed by a Security in the form provided for in Section X, Security Forms.

41. Adjudicator

41.1. The Employer may propose the person named in the BDS to be appointed as Adjudicator under the Contract. If the Bidder disagrees with this proposal, the Bidder should so state in the Bid. If, in the Letter of Acceptance, the Employer has not agreed on the bidder's nomination of the Adjudicator, the Adjudicator may be appointed by mutual consent.

42. Complaint and Review

42.1. If the Bidder has or is likely to suffer, loss or injury due to breach of a duty imposed on the Employer by the provisions of this bidding document, the bidder shall submit the complaint in writing to the Employer within ten (10) days from the date of letter of intent to award the contract pursuant to ITB 37.1

42.2. The head of agency shall, within 7 days after the submission of the complaint, issue a written decision.

42.3. The Bidder may appeal to the Independent Review Body within 5 days of the decision of the Head of the Procuring Agency or, where no such decision has been taken, within 15 days of the original complaint and the copy of the appeal shall be given to procuring agency on the same day.

42.4. Once the appeal copy is received by the procuring agency, it shall not proceed further with the procurement process until receipt of notification from the Independent Review Body Secretariat.

SECTION II. BIDDING DATA SHEET³⁶

A. General	
ITB 1.1	The Employer is <i>Chhukha Dzongkhag Administration</i> <i>The name and identification of the contract are Construction of Farmers Outlet at Gedu under Chhukha Dzongkhag</i> <i>The Works are Construction of Farmers Outlet at Gedu under Chhukha Dzongkhag</i>
ITB 1.2	The Intended Completion Date is <i>10 months</i>
B. Bidding Documents	
ITB 8.1	The Employer's address for clarification is: <i>Sangay Pelden, Site Engineer</i>
ITB 8.2	Pre-bid Meeting is not required
C. Preparation of Bids	
ITB 10.1	The language of the bid is: <i>English</i>
ITB 11.1 (g)	Any additional materials required to be completed and submitted by the Bidders are none
ITB 12.4	The Contract is <i>not subject</i> to price adjustment in accordance with GCC Clause 48.
ITB 13.2	The authority for establishing the rates of exchange shall be the Royal Monetary Authority of Bhutan.
ITB 13.4	Bidders <i>are</i> required to substantiate the rates and prices.
ITB 14.1	The Bid shall be valid for <i>90 days</i> from the deadline for submission of Bids stipulated in ITB Clause 20.1
ITB 15.1 & 15.2	The Bid Security amount is <i>Nu.116500 addressed to Dasho Dzongdag, Chukha Dzongkhag Administration</i>
ITB 16.1	Alternative Bids <i>shall not</i> consider.
ITB 18.1	In addition to the original Bid, the number of copies is <i>one</i>
D. Submission of Bids	
ITB 19.1	Bidders may submit their Bids electronically: <i>not applicable</i>
ITB 19.3 (c)	The Employer's address for the purpose of Bid submission is Dzongkhag Conference hall, <i>Chhukha Dzongkhag Administration</i>
ITB 19.3 (d)	The name and Identification number of the contract as given in ITB 1.1 above in this sheet.

³⁶ This section should be filled out by the Employer before issuance of the Bidding Documents.

ITB 19.3 (e)	The warning shall read "DO NOT OPEN BEFORE [10/2/2020at 10am]
ITB 20.1	The deadline for submission of Bids shall be [10/2/2020 at 9:30am]
E. Bid Opening and Evaluation	
ITB 23.1	The Bid opening shall take place on the same day as the closing day of the bid submission at: [at Dzongkhag conference hall] Date: [10/2/2020]; Time:[10:00am]
ITB 33.1	Maximum percentage of subcontracting permitted is 0% of the total contract amount or percentage of volume of work.
ITB 34.1	Margin of domestic preference of ten 10% shall not apply
ITB 34.3 (d)	Other criteria to be used for the purpose of assessing domestic preference eligibility are: none
F. Award of Contract	
ITB 39.1	The Performance Security shall be provided in any one of the following forms: (a) Demand guarantee in the form provided for in Section X, Security Forms, or (b) Banker's certified cheque/cash warrant, or (c) Demand draft.

ITB 40	The Advance Payment shall be limited to ten percent (10%) of the Contract Price.
ITB 41	Disputes arising from the implementation of the provisions of the Contract shall be settled first by negotiations between the Contractor and the Employer in order to arrive at an amicable settlement. If negotiations fail between the parties, the dispute shall be referred to the CDB and finally resolved by Arbitration in accordance with rules and procedures of CDB enforced at the time of submission through its National Arbitration Committee. Either party can take the case to the court in Bhutan if the Arbitration award is not acceptable to them. If the case is taken to the court, all the decisions made by the Arbitration committee will be null & void.

SECTION IV. EVALUATION AND QUALIFICATION CRITERIA

This section contains all the criteria that the Employer shall use to evaluate Bids and qualify Bidders through post-qualification. No other factors, methods or criteria shall be used other than specified in this bidding document. The Bidder shall provide all the information requested in the forms included in Section V, Bidding Forms.

1. Margin of Preference	33
2. Evaluation	33
3. Qualification.....	33
3.1. Eligibility	33
3.2. CAPABILITY (70 points)	33
3.2.1. Similar Work Experience (0-10 points):	33
3.2.2. Access to adequate equipments (0-25 points):	34
3.2.3. Access to skilled manpower (0-25points):.....	35
3.2.4. Average performance score from previous works (0-10 points):	35
3.3. CAPACITY (30 points):	36
3.3.1. Bid Capacity (0-25 points):	36
3.3.2. Credit Line available (unused) (0-5 points):	36
4. Minimum Technical Score	37
5. Award:	37
5.1. Status (Incorporated, JV or Proprietorship) (0-40 points):.....	37
5.2. Employment of Bhutanese (0-60 points):.....	37
5.3. Award of Work:.....	38

1. Margin of Preference

If BDS specifies, the Employer will grant a margin of preference of ten percent (10%) to domestic contractors, in accordance with, and subject to, the following provisions:

- (a) Contractors applying for such preference shall be asked to provide, as part of the data for qualification, such information, including details of ownership, as shall be required to determine whether, according to the classification established by the Construction Development Board and accepted by the employer, a particular contractor or group of contractors qualifies for a domestic preference. The bidding document shall clearly indicate the preference and the method that will be followed in the evaluation and comparison of Bids to give effect to such preference.
- (b) After Bids have been received and reviewed by the Employer, responsive Bids shall be classified into the following groups:
 - (i) (Group A: Bids offered by domestic contractors eligible for the preference.
 - (ii) Group B: Bids offered by other contractors.

All evaluated Bids in each group shall, as a first evaluation step, be compared to determine the Bid with lowest evaluated cost, and the Bid with the lowest evaluated cost in each group shall be further compared with each other. If a result of this comparison, a Bid from Group A is the lowest, it shall be selected for the award as the Most Advantageous Bid, if the Bidder is qualified. If a Bid from Group B is the lowest, as a second evaluation step, all Bids from Group B shall then be further compared with the lowest evaluated cost from Group A. For the purpose of this further comparison only, an amount equal to ten percent (10) of the respective Bid price corrected for arithmetical errors, including unconditional discounts but excluding provisional sums and the cost of day works, if any, shall be added to the evaluated cost offered in each Bid from Group B. If the Bid from Group A is the lowest, it shall be selected for award. If not, the lowest evaluated cost from Group B based on the first evaluation step shall be selected.

The Employer shall use the criteria and methodologies listed in this Section to evaluate Bids. By applying these criteria and methodologies, the Employer shall determine the Most Advantageous Bid. This is the Bid that has been determined to be:

- (a) substantially responsive to the bidding document, and
- (b) the lowest evaluated cost.

2. Evaluation

In addition to the criteria listed in ITB 29.2 (a) – (d) the following criteria shall apply:

3. Qualification

3.1. Eligibility

Assess the eligibility as per the ITB clause 3 requirements

3.2. CAPABILITY (70 points)

3.2.1. Similar Work Experience (0-10 points): The Employer shall consider the aggregate size of similar works (maximum three) or size of the largest similar work in the last five (5) calendar years.

The evaluation score for this parameter shall be auto-generated from e-tool based on the following scoring criteria and similar work experience information updated in the e-tool/ CiNET maintained by CDB.

Parameter	Levels of Achievement	Score
Aggregate size of similar contracts(max 3) in the last 5 calendar years OR	<input type="checkbox"/> \geq 175% of current project size	<input type="checkbox"/> 10
	<input type="checkbox"/> 125-175% of the current project size	<input type="checkbox"/> 8
	<input type="checkbox"/> 75-125% of the current project size	<input type="checkbox"/> 4
	<input type="checkbox"/> <75% of the current project size	<input type="checkbox"/> 0
Size of the largest similar contract executed in the last 5 calendar years	<input type="checkbox"/> \geq 100% of current project size	<input type="checkbox"/> 10
	<input type="checkbox"/> 70-100% of the current project size	<input type="checkbox"/> 8
	<input type="checkbox"/> 50-70% of the current project size	<input type="checkbox"/> 4
	<input type="checkbox"/> <50% of the current project size	<input type="checkbox"/> 0

The bidder shall be responsible for updating the similar work experience information in the e-tool/CiNET to secure accurate score on this parameter.

3.2.2. **Access to adequate equipments (0-25 points):** The Bidder should demonstrate that it will have access to the key Contractor's equipment listed below:

Tier	Equipment	Number Required	Max. Marks
Tier I	Excavator	1	20
	Tripper	1	15
	Tripper	1	15
Tier II	Concrete mixture	1	15
Tier 11	Levelling equipment	1	15
Tier III	vibrator	1	20
		Total	100

Bidder shall get 100% marks if the equipment is owned and 75% marks if hired.

The Bidder shall provide following details of proposed items of equipment using the relevant Form in Section V:

1. Copy of the registration certificate of each equipment committed
2. Copy of Insurance policy for each equipment where applicable
3. In case of hiring, copy of the lease agreement (specific to the project) in addition to 1 & 2 above
4. In case of equipment's that do not require registration with RSTA copy of cash memos stamped by RRCO if newly imported or copy of sale deeds or verification letter issued by a Government Engineer.

3.2.3. **Access to skilled manpower (0-25points):** The skilled and experienced manpower required for the timely and quality execution of the work to be made available for the Contract by the Bidder shall be as specified below:

[Procuring agency to specify requirements for each tier as applicable]

<i>Tier</i>	<i>Position</i>	<i>Qualification & Experience</i>	<i>Score</i>
<i>Tier 1</i>	<i>Site Engineer(civil)</i>	<i>Graduate in civil Engineering with 3+years' experience or diploma in Civil Engineering with 5+years' Experience</i>	<i>25</i>
<i>Tier 1</i>	<i>Site Engineer(civil)</i>	<i>Graduate in civil engineering with 2+ years' Experience or Diploma in civil Engineering with 3+ years' Experience</i>	<i>15</i>
<i>Tier 1</i>	<i>Site Engineer(civil)</i>	<i>Fresh Graduate in civil engineering or diploma in civil Engineering with 1 year experience</i>	<i>10</i>
<i>Tier1</i>	<i>Site Engineer(civil)</i>	<i>Any other level of qualification</i>	<i>0</i>
<i>Tier 1</i>	<i>Site Engineer(Electrical)</i>	<i>Graduate in electrical Engineering with 3+years' experience or diploma in Civil Engineering with 5+years' Experience</i>	<i>25</i>
<i>Tier 1</i>	<i>Site Engineer(Electrical)</i>	<i>Graduate in electrical Engineering with 2+years' experience or diploma in Electrical Engineering with 5+years' Experience</i>	<i>15</i>
<i>Tier 1</i>	<i>Site Engineer(Electrical)</i>	<i>Fresh Graduate in Electrical engineering or diploma in Electrical Engineering with 1 year experience</i>	<i>10</i>
<i>Tier 1</i>	<i>Site Engineer (Electrical)</i>	<i>Any other level of qualification</i>	<i>0</i>
<i>Tier11</i>	<i>Project Manager</i>	<i>Graduate with 2+years' Experience or diploma with 3+years' experience in any field</i>	<i>30</i>
<i>Tier11</i>	<i>Project Manager</i>	<i>Any other level of qualification</i>	<i>0</i>
<i>Tier111</i>	<i>Site supervisor</i>	<i>VTI certificate with 1 year experience</i>	<i>20</i>
<i>Tier111</i>	<i>Site Supervisor</i>	<i>Any other level of qualification</i>	<i>0</i>

Following are the rules that govern the scoring on equipment:

The Bidder shall provide following details of the proposed manpower and their experience records in the relevant Forms included in Section V, Bidding Forms:

1. Original signed CVs of technical manpower committed.
2. Copies of Citizenship ID Cards or work permit/ Passport/ Election/Voter ID cards (for foreign workers) of all manpower committed.
3. Copies of contract agreements with all personnel if they have been hired on contract by the contractor.
4. Copies of Provident Fund Account Documents for all regular personnel or payrolls or Copies of monthly remittance schedule of Health Contribution and Tax Deducted at Source for all regular personnel committed for this project.
5. Certificate of technical manpower committed

3.2.4. **Average performance score from previous works (0-10 points):** The Employer shall consider the performance of contractor in the last 5 calendar years.

The evaluation score for this parameter is auto-generated from e-tool based on the following

Parameter	Levels of achievement	Score
Average performance score from previous works(past 5 calendar years)	<input type="checkbox"/> 100% <input type="checkbox"/> 1 mark lesser for every 5% point decrease in score rounded off to lower 5% <input type="checkbox"/> <55%	<input type="checkbox"/> 10 <input type="checkbox"/> 0

The bidder shall be responsible to update the performance score information in e-tool/CiNET.

3.3. CAPACITY (30 points): list all information requested below

3.3.1. **Bid Capacity (0-25 points):** The bidder shall be awarded maximum of 25 points based on following criteria. The score for this parameter shall be auto-generated from e-tool based on the information updated by the bidder with e-tool/CiNET:

Parameter	Levels of achievement	Score
Bid Capacity	<input type="checkbox"/> Bid Capacity \geq quoted bid	<input type="checkbox"/> 25
	<input type="checkbox"/> Bid Capacity is between 80-100% quoted bid	<input type="checkbox"/> 20
	<input type="checkbox"/> Bid Capacity is between 60-80% quoted bid	<input type="checkbox"/> 15
	<input type="checkbox"/> Bid Capacity is between 40-60% quoted bid	<input type="checkbox"/> 10
	<input type="checkbox"/> Bid Capacity < 40% quoted bid	<input type="checkbox"/> 0

The Bid Capacity is calculated using the following formula

$$\text{Bid Capacity} = 2 \cdot A \cdot N - B$$

Where A = Average turnover of the contractor over the last 3 calendar years
 N = Estimated duration of the project to be tendered
 B = Portion of other ongoing works to be completed in the period that overlaps with the current project's duration (that is, N)

The bidder shall be responsible for updating the above information in e-tool/CiNET.

3.3.2. **Credit Line available (unused) (0-5 points):** The Bidder shall demonstrate that it has access to lines of credit sufficient to meet the construction cash flow requirements estimated as Nu. 14,60,000.

The employer shall award points based on following criteria:

Parameter	Level of achievement	Score
Credit Line Available (unused)	<input type="checkbox"/> \geq 100% of estimated 3 months project cash flow	<input type="checkbox"/> 5
	<input type="checkbox"/> 80-100% of estimated 3 month project cash flow	<input type="checkbox"/> 4
	<input type="checkbox"/> 60-80% of estimated 3 month project cash flow	<input type="checkbox"/> 2
	<input type="checkbox"/> <60% off estimated 3 month project cash flow	<input type="checkbox"/> 0

The Bidder shall provide following details in the relevant Forms included in Section V, Bidding Forms

1. The Bidder shall submit from the bank or financial institutions in Bhutan showing evidence of access to or availability of credit line for the project using relevant form.

4. Minimum Technical Score

A bidder should obtain a score of at least 70 points out of 100 on these parameters (Capability & Capacity combined) in order to qualify for the award stage.

5. **Award:** The bids scoring minimum qualifying score of 70 points out of 100 will then be evaluated on a set of price preference parameters and financial parameters. The price preference parameter will account for a weight of 10% while the financial parameter (which is linked to the financial bid submitted by the contractor) account for a weight of 90% in the overall score.

- 5.1. **Status (Incorporated, JV or Proprietorship) (0-40 points):** The contractor shall be evaluated based on the following criteria:

Parameter	Level of achievement	Score
Status (incorporated, JV or Proprietorship)	▪ Incorporated Company bidding alone	▪ 40
	▪ Incorporated Company bidding as lead partner (>50% stake) in a bid by a joint venture	▪ 20
	▪ Incorporated Company as non-lead partner (<50% stake) in a bid by a joint venture	▪ 10
	▪ Any other (proprietorship, partnership, etc)	▪ 0

The Bidder shall provide following details in the relevant Forms included in Section V, Bidding Forms:

2. Copy of the certificate of incorporation along with updated CDB registration certificate, in case an incorporated company bidding alone.
3. Joint-venture agreement between the contractor involved and copy of the certificate of incorporation along with updated CDB registration certificate for the incorporated partner, in case two or more contractors are bidding together in a joint venture.

- 5.2. **Employment of Bhutanese (0-60 points):** The contractor shall be evaluated based on the following criteria.

Parameter	Level of achievement	Score
Employment of Bhutanese	<input type="checkbox"/> \geq 100% Project workforce to be Bhutanese	<input type="checkbox"/> 60
	<input type="checkbox"/> 80-100% Project workforce to be Bhutanese	<input type="checkbox"/> 40
	<input type="checkbox"/> 60-80% Project workforce to be Bhutanese	<input type="checkbox"/> 20
	<input type="checkbox"/> <60%Project workforce to be Bhutanese	<input type="checkbox"/> 0

The Bidder shall provide following details in the relevant Forms included in Section V, Bidding Forms:

1. Provide a list of proposed Bhutanese to be committed for the Project:

5.3. Award of Work:

The overall price preference – financial score is obtained by using the following formula for any qualified contractor (x):-

$$\frac{90\% \times (\text{Lowest quoted bid among qualifying bids}) + 10\% \text{ of the Preference Score of } x}{\text{Financial bid quoted by } x}$$

The contractor getting the highest overall price preference-financial score shall be recommended for the award of the work.

SECTION V. BIDDING FORMS

TABLE OF FORMS

1. Contractor's Bid	40
2. Bill of Quantities	42
3. Form of Bid Security (Bank Guarantee)	44
4. Bidder Information Form	45
5. Bidder's JV Information Form.....	46
6. Access to Adequate Equipment (Owned or Hired):	47
7. Availability of Skilled Manpower:	47
8. Access to or Availability of Credit Line	48
9. Price Preference Parameters: List All Information Requested Below	50
10. Integrity Pact.....	51
11. Letter of Intent	54

1. Contractor’s Bid

Notes on Form of Contractor’s Bid
The Bidder shall fill in and submit this Bid form with the Bid.

[date]

Identification No. and Title of Contract: *[insert identification number and title of Contract]*

To: *[name and address of Employer]*

Having examined the all the Bidding Documents (with reference ITB 7), including addenda *[insert list]*, we offer to execute the *[name and identification number of Contract]* in accordance with the Conditions of Contract accompanying this Bid for the Contract Price of *[insert amount in numbers]*, *[insert amount in words]* *[insert name of currency]*.

This Bid and your written acceptance of it shall constitute a binding Contract between us. We understand that you are not bound to accept the lowest or any Bid you receive.

We hereby confirm that this Bid complies with the Bid validity and Bid Security required by the Bidding Documents and specified in the Bidding Data Sheet.

We, including any subcontractors or suppliers for any part of the Contract, have nationalities from eligible countries in accordance with ITB Sub-Clause 3.1;

We have no conflict of interest in accordance with ITB Sub-Clause 3.3;

Our firm, its affiliates or subsidiaries—including any subcontractors or suppliers for any part of the Contract—has not been declared ineligible under the laws or official regulations of Bhutan, in accordance with ITB Sub-Clause 3.4.

Commissions or gratuities, if any, paid or to be paid by us to agents relating to this Bid, and to contract execution if we are awarded the contract, are listed below:

Name and address of agent	Amount and Currency	Purpose of Commission or gratuity

(if none, state “none”).”

In case if I withdraw my bid after opening for whatsoever reasons, *I agree to the* forfeiture of the EMD/Bid Security and also I shall be bound to pay the cost difference (positive) between my bid with that of the next lowest evaluated bidder and failure on my part to do so within a month, will authorize the client to debar my firm for a period of 2 years.

Our duly executed Integrity Pact Statement is attached herewith as Appendix A.

Authorized Signature: _____

(Affix Legal Stamp)

Name and Title of Signatory: _____

Name of Bidder: _____

Address: _____

2. (a) Bill of Quantities³⁷

Notes on the Bill of Quantities

Objectives

The objectives of the Bill of Quantities are:

- (a) to provide sufficient information on the quantities of Works to be performed to enable Bids to be prepared efficiently and accurately; and*
- (b) when a Contract has been entered into, to provide a priced Bill of Quantities for use in the periodic valuation of Works executed.*

In order to attain these objectives, Works should be itemized in the Bill of Quantities in sufficient detail to distinguish between the different classes of Works, or between Works of the same nature carried out in different locations or in other circumstances which may give rise to different considerations of cost. Consistent with these requirements, the layout and content of the Bill of Quantities should be as simple and brief as possible.

Daywork Schedule

A Day work Schedule should be included only if the probability of unforeseen work, outside the items included in the Bill of Quantities, is high. To facilitate checking by the Employer of the realism of rates quoted by the Bidders, the Day work Schedule should normally comprise the following:

- (a) A list of the various classes of labor, materials and Constructional Plant for which basic Day work rates or prices are to be inserted by the Bidder, together with a statement of the conditions under which the Contractor will be paid for work executed on a Day work basis.*
- (b) Nominal quantities for each item of Day work, to be priced by each Bidder at Day work rates as Bid. The rate to be entered by the Bidder against each basic Day work item should include the Contractor's profit, overheads, supervision and other charges.*

³⁷ In lump sum contracts the Bill of Quantities is prepared for information; it is not contractual. The contractual document prepared by the Bidder shall be a Schedule of Activities.

Provisional Sums

A general provision for physical contingencies (quantity overruns) may be made by including a provisional sum in the Summary Bill of Quantities. Similarly, a contingency allowance for possible price increases should be provided as a provisional sum in the Summary priced Bill of Quantities. The inclusion of such provisional sums often facilitates budgetary approval by avoiding the need to request periodic supplementary approvals as the future need arises. Where such provisional sums or contingency allowances are used, the Special Conditions of Contract should state the manner in which they will be used, and under whose authority (usually the Project Manager's).

The estimated cost of specialized work to be carried out, or of special goods to be supplied, by other contractors (refer to Clause 8 of the General Conditions of Contract) should be indicated in the relevant part of the Bill of Quantities as a particular provisional sum with an appropriate brief description. A separate procurement procedure is normally carried out by the Employer to select such specialized contractors. To provide an element of competition among the Bidders in respect of any facilities, amenities, attendance, etc., to be provided by the successful Bidder as prime Contractor for the use and convenience of the specialist contractors, each related provisional sum should be followed by an item in the Bill of Quantities inviting the Bidder to quote a sum for such amenities, facilities, attendance, etc.

These Notes for Preparing a Bill of Quantities are intended only as information for the Employer or the person drafting the Bidding Documents. They should not be included in the final documents.

2. (b) Bill of Quantities

Item no.	Description	Unit	Quantity	Rate	Amount
				Total	_____

3. Form of Bid Security (Bank Guarantee)

[The **Bank/Bidder** shall fill in this Bank Guarantee form in accordance with the instructions indicated in brackets.]

[Bank's Name, and Address of Issuing Branch or Office]

Beneficiary: _____ [Name and Address of Employer]

Date: _____

BID GUARANTEE No.: _____

We have been informed that [name of the Bidder] (hereinafter called "the Bidder") has submitted to you its Bid dated (hereinafter called "the Bid") for the execution of [name of contract] under Invitation for Bids No. [IFB number] ("the IFB").

Furthermore, we understand that, according to your conditions, Bids must be supported by a Bid Guarantee.

At the request of the Bidder, we [name of Bank] hereby irrevocably undertake to pay you any sum or sums not exceeding in total an amount of [amount in figures] ([amount in words]) upon receipt by us of your first demand in writing accompanied by a written statement stating that the Bidder is in breach of its obligation(s) under the bid conditions, because the Bidder:

- (a) has withdrawn its Bid during the period of Bid validity specified by the Bidder in the Form of Bid; or
- (b) having been notified of the acceptance of its Bid by the Employer during the period of Bid validity, (i) fails or refuses to execute the Contract Form, if required, or (ii) fails or refuses to furnish the Performance Security, in accordance with the Instructions to Bidders.

This guarantee will expire: (a) if the Bidder is the successful Bidder, upon our receipt of copies of the Contract signed by the Bidder and the Performance Security issued to you upon the instruction of the Bidder; or (b) if the Bidder is not the successful Bidder, upon the earlier of (i) our receipt of a copy of your notification to the Bidder of the name of the successful Bidder; or (ii) 30 days after the expiration of the Bidder's Bid.

Consequently, any demand for payment under this guarantee must be received by us at this office on or before that date.

[signature(s)]

4. Bidder Information Form

Date: _____

RFB No. and title: _____

Bidder's name
In case of Joint Venture (JV), name of each member:
Bidder's actual or intended country of registration: <i>[indicate country of Constitution]</i>
Bidder's actual or intended year of incorporation:
Bidder's legal address [in country of registration]:
Bidder's authorized representative information Name: _____ Address: _____ Telephone/Fax numbers: _____ E-mail address: _____
<p>1. Attached are copies of original documents of</p> <p><input type="checkbox"/> Articles of Incorporation (or equivalent documents of constitution or association), and/or documents of registration of the legal entity named above, in accordance with ITB 3</p> <p><input type="checkbox"/> In case of JV, letter of intent to form JV or JV agreement, in accordance with ITB 11.2</p> <p><input type="checkbox"/> In case of state-owned enterprise or institution, in accordance with ITB 3.5, documents establishing:</p> <p><input checked="" type="checkbox"/> Legal and financial autonomy</p> <p><input checked="" type="checkbox"/> Operation under commercial law</p> <p><input checked="" type="checkbox"/> That the Bidder are not dependent agency of the Employer</p> <p>2. Included are the organizational chart, a list of Board of Directors, and the beneficial ownership.</p>

5. Bidder's JV Information Form
(to be completed for each member of Bidder's JV)

Date: _____

RFB No. and title: _____

Bidder's JV name:
JV member's name:
JV member's country of registration:
JV member's year of constitution:
JV member's legal address in country of constitution:
JV member's authorized representative information Name: _____ Address: _____ Telephone/Fax numbers: _____ E-mail address: _____
1. Attached are copies of original documents of <input type="checkbox"/> Articles of Incorporation (or equivalent documents of constitution or association), and/or registration documents of the legal entity named above, in accordance with ITB 3. <input type="checkbox"/> In case of a state-owned enterprise or institution, documents establishing legal and financial autonomy, operation in accordance with commercial law, and that they the Bidder are not dependent agency of the Employer, in accordance with ITB 3.5. 2. Included are the organizational chart, a list of Board of Directors, and the beneficial ownership.

6. Access to adequate equipment (owned or hired):

Tier	Equipment Type	Owned(No)	Hired (No)	Total (No)
I				
II				
III				

7. Availability of skilled manpower:

Tier	Name	Number	Qualifications	Years of experience
I				
II				
III				

8. Access to or Availability of Credit Line

*[The **Bank/Bidder** shall fill in this Bank Certificate form in accordance with the instructions indicated in brackets.]*

(Bank Letter Head)

(a) BANK CERTIFICATE

This is to certify that Mr./Mrs.....Promoter of M/s.....is one of our valued Clients and Maintaining account with..... Branch Officetheir dealing with bank has been satisfactory as on date.

This certificate is issued at the request of M/s..... for the purpose of participating in bidding for tender works(*insert name of works*).The Client can be considered good for line of credit to the extent of Nu.....to meet their working capital requirements for executing the work namely subject to fulfillment of lending norms.

[insert signature(s) of authorized representative(s) of bank]
Address of the Bank

*[The **Bank/Bidder** shall fill in this Bank Certificate form in accordance with the instructions indicated in brackets.]*

❖ ***For joint venture change the text as follows***

(Bank Letter Head)

(b) BANK CERTIFICATE

This is to certify that Mr./Mrs..... Promoter of M/s..... who has formed a Joint Venture with M/s..... for participating in this bid is one of our valued Clients and Maintaining account with Branch Office,..... their dealing with bank has been satisfactory as on date.

This certificate is issued at the request of M/s..... for the purpose of participating in bidding for tender works (*insert name of works*).The Client can be considered good for line of credit to the extent of Nu.....to meet their working capital requirements for executing the work namely..... subject to fulfillment of lending norms

[insert signature(s) of authorized representative(s) of bank]
Address of the Bank

[This should be given by each JV members]

9. PRICE PREFERENCE PARAMETERS: list all information requested below.

9.(a) Status (Incorporated, JV, proprietorship)

Particulars	Response
Constitution or legal status of Bidder	<i>[To be filled by bidders]</i>
Place of registration	<i>[To be filled by bidders]</i>
Principal place of business	<i>[To be filled by bidders]</i>

The bidder shall submit the following supporting documents for the above:

- Copy of the certificate of incorporation issued by the registrar of companies for the bidder in case an incorporated company is bidding alone.
- Joint-venture agreement between the contractor involved, and copy of the certificate of incorporation issued by the registrar of companies for the incorporated partner in case two or more contractors are bidding together in a joint venture.

9.(b) Employment of Bhutanese

Description	Response
Total Number of project workforce (<i>Bhutanese and Non-Bhutanese key technical Personnel, skilled & non-skilled personnel</i>) to be committed for the project	<i>[To be filled by bidders in numbers]</i>
Number of Bhutanese committed for the project	<i>[To be filled by bidders in numbers]</i>

10. INTEGRITY PACT

1. General:

Whereas (*Name of head of the procuring agency or his/her authorized representative, with power of attorney*) representing the (*Name of procuring agency*), Royal Government of Bhutan, hereinafter referred to as the “**Employer**” on one part, and (*Name of bidder or his/her authorized representative, with power of attorney*) representing M/s. (*Name of firm*), hereinafter referred to as the “**Bidder**” on the other part hereby execute this agreement as follows:

This agreement shall be a part of the standard bidding document, which shall be signed by both the parties at the time of purchase of bidding documents and submitted along with the tender document. This IP is applicable only to “**large**” scale works, goods and services, the threshold of which will be announced by the government from time to time. The signing of the IP shall not apply to framework contracting such as annual office supplies etc.

2. Objectives:

Whereas, the Employer and the Bidder agree to enter into this agreement, hereinafter referred to as IP, to avoid all forms of corruption or deceptive practice by following a system that is fair, transparent and free from any influence/unprejudiced dealings in the **bidding process**³⁸ and **contract administration**³⁹, with a view to:

- 2.1. Enabling the Employer to obtain the desired contract at a reasonable and competitive price in conformity to the defined specifications of the works or goods or services; and
- 2.2. Enabling bidders to abstain from bribing or any corrupt practice in order to secure the contract by providing assurance to them that their competitors will also refrain from bribing and other corrupt practices.

3. Scope:

The validity of this IP shall cover the bidding process and contract administration period.

4. Commitments of the Employer:

The Employer Commits itself to the following:-

- 4.1. The Employer hereby undertakes that no officials of the Employer, connected directly or indirectly with the contract, will demand, take a promise for or accept, directly or through intermediaries, any bribe, consideration, gift, reward, favor or any material or immaterial benefit or any other advantage from the Bidder, either for themselves or for any person, organization or third party related to the contract in exchange for an advantage in the bidding process and contract administration.
- 4.2. The Employer further confirms that its officials shall not favor any prospective bidder in any form that could afford an undue advantage to that particular bidder in the bidding process and contract administration and will treat all Bidders alike.

³⁸ Bidding process, for the purpose of this IP, shall mean the procedures covering tendering process starting from bid preparation, bid submission, bid processing, and bid evaluation.

³⁹ Contract administration, for the purpose of this IP, shall mean contract award, contract implementation, un-authorized sub-contracting and contract handing/taking over.

- 4.3. Officials of the Employer, who may have observed or noticed or have reasonable suspicion shall report to the head of the employing agency or an appropriate government office any violation or attempted violation of clauses 4.1 and 4.2.
- 4.4. Following report on violation of clauses 4.1 and 4.2 by official (s), through any source, necessary disciplinary proceedings, or any other action as deemed fit, including criminal proceedings shall be initiated by the Employer and such a person shall be debarred from further dealings related to the bidding process and contract administration.

5. Commitments of Bidders

The Bidder commits himself/herself to take all measures necessary to prevent corrupt practices, unfair means and illegal activities during any stage of the bidding process and contract administration in order to secure the contract or in furtherance to secure it and in particular commits himself/herself to the following :

- 5.1. The Bidder shall not offer, directly or through intermediaries, any bribe, gift, consideration, reward, favor, any material or immaterial benefit or other advantage, commission, fees, brokerage or inducement to any official of the Employer, connected directly or indirectly with the bidding process and contract administration, or to any person, organization or third party related to the contract in exchange for any advantage in the bidding process and contract administration.
- 5.2. The Bidder shall not collude with other parties interested in the contract to manipulate in whatsoever form or manner, the bidding process and contract administration.
- 5.3. If the bidder(s) have observed or noticed or have reasonable suspicion that the provisions of the IP have been violated by the procuring agency or other bidders, the bidder shall report such violations to the head of the procuring agency.

6. Sanctions for Violation:

The breach of any of the aforesaid provisions shall result in administrative charges or penal actions as per the relevant rules and laws.

- 6.1. The breach of the IP or commission of any offence (forgery, providing false information, misrepresentation, providing false/fake documents, bid rigging, bid steering or coercion) by the Bidder, or any one employed by him, or acting on his/her behalf (whether with or without the knowledge of the Bidder), shall be dealt with as per the terms and conditions of the contract and other provisions of the relevant laws, including De-barment Rules.
- 6.2. The breach of the IP or commission of any offence by the officials of the procuring agency shall be dealt with as per the rules and laws of the land in vogue.

7. Monitoring and Administration:

- 7.1. The respective procuring agency shall be responsible for administration and monitoring of the IP as per the relevant laws.
- 7.2. The bidder shall have the right to appeal as per the arbitration mechanism contained in the relevant rules.

11. Letter of Intent

(Letterhead paper of the Employer)

Notes on standard form of letter of Intent

This issuance of Letter of Intent (always before letter of acceptance) is the information of the selection of the bid of the successful bidder by the Employer and for providing information to other unsuccessful bidders who participated in the bid as regards the outcome of the procurement process

The Employer shall allow 10 days as described in ITB 37 between this letter of intent and letter of acceptance to allow aggrieved bidders to complaint the decision if they feel they have treated unfairly.

(Insert date)

To: ----- *[Name and address of the Contractor]*

This is to notify you that, it is our intention to award the contract for your Bid dated *[Insert date]* for execution of the..... *[Insert name of the contract and identification number, as given in the BDS/SCC]* for the Contract Price of..... *[Insert amount in figure and words & name of currency]* as corrected and modified *[if any corrections]* in accordance with the Instructions to Bidders.

Authorized Signature: -----

Name and Title of Signatory: -----

Name of Agency: -----

CC:*[Insert name and address of all other bidders who submitted the bids]*

SECTION VI. GENERAL CONDITIONS OF CONTRACT (GCC)

Notes on General Conditions of Contract

The General Conditions of Contract (GCC), read in conjunction with the Special Conditions of Contract and other documents listed therein, should be a complete document expressing fairly the rights and obligations of both parties.

The form of General Conditions of Contract that follows has been developed on the basis of considerable international experience in the drafting and management of contracts, bearing in mind a trend in the construction industry towards simpler, more straightforward language.

The form can be used directly for smaller ad measurement (unit prices or unit rates in a Bill of Q3 quantities) contracts and, with the modifications noted in the footnotes, it can be adapted for lump sum contracts.

The use of standard General Conditions of Contract for building and civil works will promote comprehensiveness of coverage, general acceptability of its provisions, savings in cost and time in Bid preparation and review, and the development of a solid background of legal case histories.

TABLE OF CLAUSES

A. General	58
1. Definitions.....	58
2. Interpretation	60
3. Language and Law	60
4. Project Manager's Decisions.....	60
5. Delegation	60
6. Communications.....	60
7. Subcontracting.....	60
8. Setting Out.....	61
9. Other Contractors	61
10. Personnel	61
11. Employer's and Contractor's Risks	62
12. Employer's Risks	62
13. Contractor's Risks.....	63
14. Insurance.....	63
15. Queries about the Special Conditions of Contract.....	63
16. Contractor to Construct the Works.....	63
17. The Works to Be Completed by the Intended Completion Date.....	63
18. Approval by the Project Manager	64
19. Safety	64
20. Discoveries	64
21. Possession of the Site	64
22. Access to the Site	65
23. Instructions, Inspections and Audits.....	65
24. Disputes	65
25. Procedure for Disputes	65
26. Replacement of Adjudicator	66
B. Time Control	66
27. Program.....	66
28. Progress Reports.....	67
29. Extension of the Intended Completion Date	67
30. Acceleration.....	67
31. Delays Ordered by the Project Manager	68
32. Management Meetings	68
33. Early Warning	68
C. Quality Control.....	69
34. Identifying Defects	69
35. Tests.....	69
36. Correction of Defects	69
37. Uncorrected Defects	69
D. Cost Control.....	69
38. Bill of Quantities.....	69
39. Changes in the Quantities.....	70

Section VI. General Conditions of Contract (GCC)	57
40. Variations	71
41. Payments for Variations.....	72
42. Cash Flow Forecasts	72
43. Payment Certificates.....	72
44. Payments	73
45. Compensation Events for allowing time extension	74
46. Tax.....	75
47. Currencies	75
48. Price Adjustment.....	75
49. Retention	76
50. Liquidated Damages.....	76
51. Advance Payment.....	77
52. Securities.....	78
53. Day works.....	78
54. Cost of Repairs.....	78
E. Completion of the Contract.....	78
55. Completion	78
56. Taking Over	79
57. Final Account.....	79
58. Operating and Maintenance Manuals	79
59. Termination.....	80
60. Corrupt or Fraudulent Practices	81
61. Payment upon Termination.....	83
62. Property.....	83
63. Release from Performance	83

General Conditions of Contract**A. General****1. Definitions****1.1. Boldface type is used to identify defined terms.**

- (a) The **Adjudicator** is the person appointed jointly by the Employer and the Contractor to resolve disputes in the first instance, as provided for in GCC Clauses 25 and 26 hereunder.
- (b) **Bill of Quantities** summary of the units and unit prices of the items proposed under the contract.
- (c) **Compensation Events** are those defined in GCC Clause 45 hereunder.
- (d) The **Completion Date** is the date of completion of the Works as certified by the Employer, in accordance with GCC Sub-Clause 55.1.
- (e) The **Contract** is a formal agreement in writing entered into between the Employer and the Contractor to execute, complete, and maintain the Works. It consists of the documents listed in GCC Sub-Clause 2.3 below.
- (f) The **Contractor** is an individual or legal entity entering into a contract after its Bid to carry out the Works has been accepted by the Employer.
- (g) The **Contractor's Bid** is the completed Bidding document submitted by the Contractor to the Employer.
- (h) The **Contract Price** is the price stated in the Letter of Acceptance and thereafter as adjusted in accordance with the provisions of the Contract.
- (i) **Days** are calendar days; months are calendar months.
- (j) **Day works** are varied work inputs subject to payment on a time basis for the Contractor's employees and Equipment, in addition to payments for associated Materials and Plant.
- (k) A **Defect** is any part of the Works not completed in accordance with the Contract.
- (l) The **Defects Liability Certificate** is the certificate issued by the Employer upon correction of defects by the Contractor.
- (m) The **Defects Liability Period** is the period named in SCC Sub-Clause 36.1 and calculated from the Completion Date.
- (n) **Drawings** include calculations and other information provided or approved by the Employer for the execution of the Contract.
- (o) The **Employer** is the Government Agency which enters into a Contract with a Contractor to carry out the Works, as specified in the SCC. The terms "Procuring Agency", "Purchaser", or "Employer" is synonymous.
- (p) **Equipment** is the Contractor's machinery and vehicles brought temporarily to the Site to construct the Works.

- (q) The **Initial Contract Price** is the Contract Price listed in the Employer's Letter of Acceptance.
- (r) The **Intended Completion Date** is the date on which it is intended that the Contractor shall complete the Works. The Intended Completion Date is specified in the SCC. The Intended Completion Date may be revised only by the Employer by issuing an extension of time or an acceleration order.
- (s) **In writing** is in any written form, including electronic mail.
- (t) **Materials** are all supplies, including consumables, used by the Contractor for incorporation in the Works.
- (u) **Plant** is any integral part of the Works that shall have a mechanical, electrical, chemical or biological function.
- (v) The **Project Manager** is the person named in the SCC (or any other competent person appointed by the Employer and notified to the Contractor, to act in replacement of the Employer) who is responsible for supervising the execution of the Works and administering the Contract.
- (w) **SCC** is the Special Conditions of Contract.
- (x) **Secured Advance**: Secured advance can be given for non-perishable materials only. Materials such as cement/bamboo cannot be eligible for the secured advance. No secured advance shall be given on account of plants & machineries.
- (y) The **Site** is the area defined as such in the SCC.
- (z) **Site Investigation Reports** are those that were included in the Bidding Documents and are factual and interpretative reports about the surface and subsurface conditions at the Site.
- (aa) **Specifications** mean the Specifications of the Works included in the Contract and any modification or addition made or approved by the Project Manager.
- (bb) The **Start Date** is given in the SCC. It is the latest date when the Contractor shall commence execution of the Works. It does not necessarily coincide with any of the Site Possession Dates.
- (cc) A **Subcontractor** is a person or corporate body who has a Contract with the Contractor to carry out a part of the work in the Contract, which includes work on the Site.
- (dd) **Temporary Works** are works designed, constructed, installed and removed by the Contractor that are needed for construction or installation of the Works.
- (ee) A **Variation** is an instruction given by the Project Manager which varies the Works.
- (ff) The **Works** are what the Contract requires the Contractor to construct, install and turn over to the Employer, as defined in the SCC.

- 2. Interpretation**
- 2.1. In interpreting these GCC, singular also means plural, male also means female or neuter, and the other way around. Headings have no significance. Words have their normal meaning under the language of the Contract unless specifically defined. The Project Manager shall provide instructions clarifying queries about these GCC.
- 2.2. If sectional completion is specified in the SCC, references in the GCC to the Works, the Completion Date and the Intended Completion Date apply to any Section of the Works (other than references to the Completion Date and Intended Completion Date for the whole of the Works).
- 2.3. The documents forming the Contract shall be interpreted in the following order of priority:
- (1) Contract,
 - (2) Letter of Acceptance,
 - (3) Contractor's Bid,
 - (4) Special Conditions of Contract,
 - (5) General Conditions of Contract,
 - (6) Specifications,
 - (7) Drawings,
 - (8) Bill of Quantities,⁴⁰ and
 - (9) Any other document listed in the SCC as forming part of the Contract.
- 3. Language and Law**
- 3.1. The language of the Contract and the law governing the Contract are stated in the SCC.
- 4. Project Manager's Decisions**
- 4.1. Except where otherwise specifically stated, the Project Manager shall decide contractual matters between the Employer and the Contractor in the role representing the Employer..
- 5. Delegation**
- 5.1. The Project Manager may delegate any of his duties and responsibilities to other people except to the Adjudicator, after notifying the Contractor, and may cancel any delegation after notifying the Contractor.
- 6. Communications**
- 6.1. Communications between parties that are referred to in the Conditions shall be effective only when in writing and delivered by hand (against receipt), sent by mail or courier, or transmitted using any of the agreed systems of electronic transmission. A notice shall be effective only when it is delivered.
- 7. Subcontracting**
- 7.1. The Contractor may subcontract with the approval of the Employer provided such provisions exist in contract document, but shall not assign the Contract without the approval of the Employer in writing. Subcontracting shall not alter the Contractor's obligations.

⁴⁰ In lump sum contracts, delete "Bill of Quantities" and replace with "Activity Schedule".

- 8. Setting Out**
- 8.1. The Contractor shall be responsible for setting out the Works and for ensuring the correctness of the positions, levels, dimensions and alignment of the Works. At any time during the execution of the Works, he shall correct any error at his own expense when required to do so by the Employer. Boreholes, exploratory excavations or soil testing may be done if instructed by the Employer. In case, cost of boreholes or exploratory excavations or soil testing is not included in the Contract Price, the cost shall be borne by the Employer. The contractor shall provide all facilities like labor and instruments, and shall co-operate with the Engineer-in-Charge to check all alignments, grades, levels and dimensions. Such checking shall not relieve the contractor of his own responsibility of maintaining the accuracy of the work.
- 9. Other Contractors**
- 9.1. The Contractor shall cooperate and share the Site with other contractors, public authorities, utilities and the Employer between the dates given in the Schedule of Other Contractors, as referred to in the SCC. The Contractor shall also provide facilities and services for them as described in the Schedule. The Employer may modify the Schedule of Other Contractors, and shall notify the Contractor of any such modification.
- 10. Personnel**
- 10.1. The Contractor shall employ the key personnel named in the Schedule of Key Personnel, as referred to in the SCC, to carry out the functions stated in the Schedule or other personnel approved by the Project Manager. The Project Manager shall approve any proposed replacement of key personnel only if their relevant qualifications and abilities are substantially equal to or better than those of the personnel listed in the Schedule. If the Contractor fails to deploy the personnel as committed in the Bid document, the employer shall stop the work if the quality of work is going to suffer or otherwise deduct the salaries of such personnel at a rate stipulated in the Special Condition of Contract per month per personnel for every month of absence of such personnel from the site. Such deductions shall continue till such time that the Contractor deploys the key personnel acceptable to the employer. If the Contractor fails to deploy such key personnel within one to four months⁴¹, the deductions shall be discontinued and the contractor's failure to deploy such personnel shall be treated as a fundamental breach of contract.
- This shall also apply to the commitment of employment to Bhutanese. However in this case Contract may not be terminated but wage rates as mentioned in the SCC shall be deducted for the duration of the contract.

41 The duration should be based on the Contract duration.

Similarly, if the committed equipments are not available at site, the hiring charges of such equipments shall be deducted at a rate stipulated in the SCC per month for every month of absence for a period of one to four months after which the deductions shall be discontinued and the contractor's failure to produce such equipments at site shall be treated as a fundamental breach of contract.

10.2. The Contractor shall pay rates of wages and observe conditions of labor which are not lower than the general level of wages and conditions in Bhutan. The Contractor shall provide and maintain all necessary accommodation and welfare facilities for the Contractor's personnel. The Contractor shall comply with all relevant labor laws applicable to the Contractor's personnel, including their employment, health, safety, welfare, immigration and emigration, and shall allow them all their legal rights. The Contractor is required, to the extent practicable and reasonable, to employ national staff and labor with appropriate qualifications and experience.

10.3. The Contractor shall not engage child labor and shall conform to the labor laws/acts, rules and regulations of Bhutan in the execution of Contract work. A child who has not attained the age of 18 years shall not be employed in any work as a laborer. During the continuance of the Contract the Contractor and his Subcontractors shall abide at all times with the labor laws/acts, rules and regulations, including child labor, related enactment and rules made there under.

11. Employer's and Contractor's Risks

11.1. The Employer carries the risks which this Contract states are Employer's risks, and the Contractor carries the risks which this Contract states are Contractor's risks.

12. Employer's Risks

12.1. From the Start Date until the Defects Liability Certificate has been issued, the following are Employer's risks:

- (a) The risk of personal injury, death, or loss of or damage to property (excluding the Works, Plant, Materials and Equipment), which are due to:
 - (i) use or occupation of the Site by the Works or for the purpose of the Works, which is the unavoidable result of the Works or
 - (ii) Negligence, breach of statutory duty, or interference with any legal right by the Employer or by any person employed by or contracted to him except the Contractor.
- (b) The risk of damage to the Works, Plant, Materials and Equipment to the extent that it is due to a fault of the Employer or in the Employer's design, or due to war or radioactive contamination directly affecting Bhutan.

- 13. Contractor's Risks** 13.1. From the Start Date until the Defects Liability Certificate has been issued, the risks of personal injury, death, and loss of or damage to property (including, without limitation, the Works, Plant, Materials and Equipment) which are not Employer's risks are Contractor's risks.
- 14. Insurance** 14.1. The Contractor shall provide, in the joint names of the Employer and the Contractor, insurance cover from the Start Date to the end of the Defects Liability Period, in the amounts and deductibles stated in the SCC for the following events which are due to the Contractor's risks:
- (a) loss of or damage to the Works, Plant and Materials to be built into the works.
- 14.2. Policies and certificates for insurance shall be delivered by the Contractor to the Project Manager for the Project Manager's approval before the Start Date. All such insurance shall provide for compensation to be payable in the types and proportions of currencies required to rectify the loss or damage incurred. Payments received from insurers shall be used for the rectification of loss or damage.
- 14.3. If the Contractor does not provide any of the policies and certificates required, the Employer may affect the insurance which the Contractor should have provided and recover the premiums the Employer has paid from payments otherwise due to the Contractor or, if no payment is due, the payment of the premiums shall be a debt due from the Contractor to the Employer.
- 14.4. Alterations to the terms of insurance shall not be made without the approval of the Project Manager.
- 14.5. Both parties shall comply with any conditions of the insurance policies.
- 15. Queries about the Special Conditions of Contract** 15.1. The Project Manager shall clarify queries on the SCC.
- 16. Contractor to Construct the Works** 16.1. The Contractor shall construct and install the Works in accordance with the Specifications and Drawings.
- 17. The Works to Be Completed by the Intended Completion Date** 17.1. The Contractor may commence execution of the Works on the Start Date and shall carry out the Works in accordance with the Program submitted by the Contractor, as updated with the approval of the Project Manager, and complete them by the Intended Completion Date.

-
- 18. Approval by the Project Manager**
- 18.1. The Contractor shall submit Specifications and Drawings showing the proposed Temporary Works to the Project Manager, who is to approve them if they comply with the Specifications and Drawings.
- 18.2. The Contractor shall be responsible for design of Temporary Works.
- 18.3. The Project Manager's approval shall not alter the Contractor's responsibility for design of the Temporary Works.
- 18.4. The Contractor shall obtain approval of third parties to design the Temporary Works, where required.
- 18.5. All Drawings prepared by the Contractor for the execution of the temporary or permanent Works are subject to prior approval by the Project Manager before use.
- 19. Safety**
- 19.1. The Contractor shall be responsible for the safety of all activities on the Site.
- 19.2. The Contractor shall assume full responsibility and comply with all applicable safety regulations for the adequacy and safety of site operations and methods of construction and he shall adopt measures to prevent injuries to persons or damage to properties or utilities. He shall hold the Employer harmless from any liability for loss or damage resulting from his failures to take the necessary precautions. He shall avoid undue interference with private business, public travel, or with the work of other contractors. He shall take steps to protect the environment and to minimize noise, pollution or other undesirable effects resulting from his method of operation.
- 20. Discoveries**
- 20.1. Anything of historical or other interest or of significant value unexpectedly discovered on the Site shall be the property of the Employer. The Contractor shall notify the Project Manager of such discoveries and carry out the Employer's instructions for dealing with them.
- 20.2. All materials obtained during excavation from the site and that have not been accounted for in the bid shall be the property of the Employer and the contractor shall take care of useful materials obtained during the execution of the Works and stack at place designated by the Employer. An arrangement shall be made between the Contractor and the Employer for the use and disposal of such materials according to the laws of the kingdom of Bhutan.
- 21. Possession of the Site**
- 21.1. The Employer shall give possession of all parts of the Site to the Contractor. If possession of a part is not given by the date stated in the SCC, the Employer shall be deemed to have delayed the start of the relevant activities, and this shall be a Compensation Event.

-
- 21.2. Within 14 days of possession of site the contractor shall erect an information board as specified in SCC.
- 22. Access to the Site**
- 22.1. The Contractor shall allow the Project Manager and any person authorized by the Employer access to the Site and to any place where work in connection with the Contract is being carried out or is intended to be carried out.
- 23. Instructions, Inspections and Audits**
- 23.1. The Contractor shall carry out all instructions of the Project Manager which comply with the applicable laws where the Site is located.
- 23.2. The Contractor shall give notice to the Project Manager whenever any work is ready and before it is covered up, put out of sight, or packaged for storage or transport. The Project Manager shall then either carry out the examination, inspection, measurement or testing without unreasonable delay, or promptly give notice to the Contractor that he does not require to do so. If the Contractor fails to give the notice, he shall, if and when required by the Project Manager, uncover the work and thereafter reinstate and make good, all at the Contractor's cost.
- 23.3. The Contractor shall permit the Employer and/or persons appointed by the Employer to inspect the Site and/or the accounts and records of the Contractor and its Subcontractors relating to the performance of the Contract, and to have such accounts and records audited by auditors appointed by the Employer if so required by the Employer. The Contractor's attention is drawn to GCC Sub-Clause 60.1 [Corrupt or Fraudulent Practices] which provides, inter alia, that acts intended materially to impede the exercise of the Employer's inspection and audit rights provided for under GCC Sub-Clause 23.3 constitute a prohibited practice subject to contract termination (as well as to a determination of ineligibility pursuant to ITB Sub-Clause 2.1 (c) of the Instructions to Bidders within the Bidding Documents that preceded the placement of the Contract of which these GCC form a part).
- 24. Disputes**
- 24.1. If the Contractor believes that a decision taken by the Project Manager was either outside the authority given to the Project Manager by the Contract or that the decision was wrongly taken, the decision shall be referred to the Adjudicator within 14 days of the notification of the Project Manager's decision.
- 25. Procedure for Disputes**
- 25.1. The Adjudicator shall give a decision in writing within 30 days of receipt of a notification of a dispute.
- 25.2. Unless otherwise agreed, the parties shall comply with the adjudication procedure published by appointing authority specified in SCC.

25.3. The Adjudicator shall be paid by the hour at the rate specified in the BDS and the SCC, together with reimbursable expenses of the types specified in the SCC, and the cost shall be divided equally between the Employer and the Contractor, whatever decision is reached by the Adjudicator. If the rates are not specified in SCC, the parties shall comply with the rates fixed by appointing authority in schedule of fees. Either party may refer a decision of the Adjudicator to an Arbitrator within 30 days of the Adjudicator's written decision. If neither party refers the dispute to arbitration within the above 30 days, the Adjudicator's decision shall be final and binding.

25.4. The arbitration shall be conducted in accordance with the arbitration procedure published by the institution named and in the place specified in the SCC.

26. Replacement of Adjudicator

26.1. Should the Adjudicator resign or die, or should the Employer and the Contractor agree that the Adjudicator is not functioning in accordance with the provisions of the Contract; a new Adjudicator shall be jointly appointed by the Employer and the Contractor. In case of disagreement between the Employer and the Contractor, within 30 days, the Adjudicator shall be designated by the Appointing Authority designated in the SCC at the request of either party, within 14 days of receipt of such request.

B. Time Control

27. Program

27.1. Within the time stated in the SCC, after the date of the Letter of Acceptance, the Contractor shall submit to the Project Manager for approval a Program showing the general methods, arrangements, order and timing for all the activities in the Works.

27.2. The Contractor shall submit to the project manager for approval at intervals no longer than the period stated in the SCC a revised programme or if at any time:

- (a) actual progress is too slow to complete within the Time for Completion, and/or
- (b) progress has fallen behind or ahead the current programme under Sub-Clause 27.1 [Program],

Other than as a result of a cause listed in Sub-Clause 45 [Compensation Event], then the Project Manager may instruct the Contractor to submit, under Sub-Clause 27.2 [Program], a revised programme and supporting report describing the revised methods which the Contractor proposes to adopt in order to expedite progress and complete within the Time for Completion.

The contractor shall adopt these revised methods, which may require increases in the working hours and/or in the numbers of contractor's personnel and/or Goods, at the risk and cost of the Contractor.

Additional costs of revised methods including acceleration measures, instructed by the Project Manager to reduce delays resulting from causes listed under Sub-Clause 45 [Extension of Time for Completion] shall be paid by the Employer.

27.3. The Project Manager's approval of the Program shall not alter the Contractor's obligations. The Contractor may revise the Program and submit it to the Employer again at any time. A revised Program shall show the effect of Variations.

28. Progress Reports

28.1. Unless otherwise stated in the SCC, monthly progress reports shall be prepared by the Contractor and submitted to the Project Manager. Reports shall be submitted monthly thereafter, each within 7 days after the last day of the period to which it relates. Reporting shall continue until the Contractor has completed all works. The report shall include:

- (a) comparisons of actual and planned progress, with details of any events or circumstances which may jeopardize the completion in accordance with the Contract, and the measures being (or to be) adopted to overcome delays.
- (b) copies of quality assurance documents, test results and certificates of Materials;
- (c) charts and detailed descriptions of progress, including each stage of design (if any), delivery to Site, construction, erection and testing; and including the stages for work by subcontractor; and
- (d) any other details specified in SCC

29. Extension of the Intended Completion Date

29.1. The Project Manager shall extend the Intended Completion Date if a Variation is issued which makes it impossible for Completion to be achieved by the Intended Completion Date without the Contractor taking steps to accelerate the remaining work, which would cause the Contractor to incur additional cost.

29.2. The Project Manager shall decide whether and by how much to extend the Intended Completion Date within 21 days of the Contractor asking the Project Manager for a decision upon the effect of Variation and submitting full supporting information. If the Contractor has failed to give early warning of a delay or has failed to cooperate in dealing with a delay, the delay by this failure shall not be considered in assessing the new Intended Completion Date.

30. Acceleration

30.1. When the Employer wants the Contractor to finish before the Intended Completion Date, the Project Manager shall obtain priced proposals for achieving the necessary acceleration from the Contractor. If the Employer accepts these proposals, the Intended Completion Date shall be adjusted accordingly and confirmed by both the Employer and the Contractor.

-
- 30.2. If the Contractor's priced proposals for acceleration are accepted by the Employer, they are incorporated in the Contract Price and treated as a Variation.
- 31. Delays Ordered by the Project Manager**
- 31.1. The Project Manager may instruct the Contractor to delay the start or progress of any activity within the Works.
- 32. Management Meetings**
- 32.1. Either the Project Manager or the Contractor may require the other to attend a management meeting. The business of a management meeting shall be to review the plans for remaining work and to deal with matters raised in accordance with the early warning procedure.
- 32.2. The Project Manager shall record the business of management meetings and provide copies of the record to those attending the meeting. The responsibility of the parties for actions to be taken shall be decided by the Project Manager either at the management meeting or after the management meeting and stated in writing to all who attended the meeting.
- 33. Early Warning**
- 33.1. The Contractor shall warn the Project Manager at the earliest opportunity of specific likely future events or circumstances that may adversely affect the quality of the work increase the Contract Price or delay the execution of the Works. The Project Manager may require the Contractor to provide an estimate of the expected effect of the future event or circumstance on the Contract Price and Completion Date. The estimate shall be provided by the Contractor as soon as reasonably possible.
- 33.2. The Contractor shall cooperate with the Project Manager in making and considering proposals for how the effect of such an event or circumstance can be avoided or reduced by anyone involved in the work and in carrying out any resulting instruction of the Project Manager.
- 33.3. If the Contractor considers himself to be entitled to any extension of Time for Completion and/or any additional payment, under any Clause of these Conditions or otherwise in connection with the Contract, the Contractor shall give notice to the Project Manager, describing the event or circumstance giving rise to the claim. The notice shall be given as soon as practicable, and not later than 30 days after the Contractor became aware, or should have become aware, of the event or circumstance.
- 33.4. If the Contractor fails to give notice of a claim within such period of 30 days, the Employer shall be discharged from all liability in connection with the claim.

C. Quality Control

- 34. Identifying Defects** 34.1. The Project Manager shall check the Contractor's work and notify the Contractor of any Defects that are found. Such checking shall not affect the Contractor's responsibilities to ensure the quality of works executed. The Project Manager may instruct the Contractor to search for a Defect and to uncover and test any work that the Project Manager considers may have a Defect. The Project Manager at the end of the Contract shall issue a Performance score on Quality out of a total of 70 points based on the guidelines issued by Construction Development Board (CDB).
- 35. Tests** 35.1. If the Project Manager instructs the Contractor to carry out a test not specified in the Specifications to check whether any work has a Defect and the test shows that it does, the Contractor shall pay for the test and any samples. If there is no Defect, the test shall be a Compensation Event.
- 36. Correction of Defects** 36.1. The Project Manager shall give notice to the Contractor of any Defects before the end of the Defects Liability Period, which begins at Completion, and is defined in the SCC. The Defects Liability Period shall be extended for as long as Defects remain to be corrected.
- 36.2. Every time notice of a Defect is given, the Contractor shall correct the notified Defect within the length of time specified by the Project Manager's notice.
- 37. Uncorrected Defects** 37.1. If the Contractor has not corrected a Defect within the time specified in the Project Manager's notice, the Project Manager shall assess the cost of having the Defect corrected, and the Contractor shall pay this amount to the Employer. At the option of the Employer, payment of such costs may be made in whole or in part by the Employer deducting and keeping for itself appropriate amounts from the Retention Money and/or claiming against any bank guarantee provided by the Contractor pursuant to GCC Sub-Clause 49.3.

D. Cost Control

- 38. Bill of Quantities⁴²** 38.1. The Bill of Quantities shall contain items for the construction, installation, testing and commissioning work to be done by the Contractor.
- 38.2. The Bill of Quantities is used to calculate the Contract Price. The Contractor is paid for the quantity of the work done at the rate in the Bill of Quantities for each item.

⁴² In lump sum contracts, delete "Bill of Quantities" and replace with "Activity Schedule," and replace Sub-Clauses 37.1 and 37.2, as follows:

37.1 The Contractor shall provide updated Activity Schedules within 14 days of being instructed to do so by the Employer. The activities on the Activity Schedule shall be coordinated with the activities on the Program.

37.2 The Contractor shall show delivery of Materials to the Site separately on the Activity Schedule if payment for Materials on Site shall be made separately.

39. Changes in the Quantities⁴³

- 39.1. If the final quantity of the work done differs from the quantity in the Bill of Quantities for the particular item by more than twenty percent (20%), provided the cost of variation beyond twenty percent (20%) limit exceeds one percent (1%) of the Initial Contract Value the Employer shall adjust the quoted rate up or down to allow for the change. Only when both conditions are met then the quoted rate shall be changed.
- (a) If the quantity of work executed exceeds the quantity of the item in BOQ beyond the higher specified limit the Employer shall fix the market rate (which may be lower or higher than the quoted rate) to be applied for the additional quantity of the work executed.
- (b) If the quantity of work executed is less than the quantity of the item in BOQ lesser than the lower specified limit, the Employer shall fix the market rate based on the submission of the contractor (which may be lower/higher than the quoted rate) to be applied for whole of the quantity of the work so executed for that particular item.
- 39.2. The rates shall not be adjusted from changes in quantities if thereby the Initial Contract Price is exceeded by more than five percent (5%), except with the prior approval of the procuring agency in consultation with the Tender Committee.
- 39.3. For works upto Nu. 50 million, when quantity deviation exceeds twenty percent (20%) from the quantity in BOQ and the total cost of such deviations exceeds twenty percent (20%) of the initial contract price; prior approval shall be sought from the Competent Authority (Finance Committee constituted in respective agency).
- 39.4. For works above Nu. 50 million, when quantity deviation exceeds twenty percent (20%) from the quantity in BOQ and the total cost of such deviations exceeds twenty percent (20%) of the initial contract price; the procuring agency shall seek prior approval of the Competent Authority (Public Investment Board/Public Investment Coordination Committee).
- 39.5. If requested by the Project Manager, the Contractor shall provide the Project Manager with a detailed cost breakdown of any rate in the Bill of Quantities.

⁴³ In lump sum contracts, delete "Bill of Quantities" and replace with "Activity Schedule," and replace entire Clause 37 with new Sub-Clause 38.1, as follows:

38.1 The Activity Schedule shall be amended by the Contractor to accommodate changes of Program or method of working made at the Contractor's own discretion. Prices in the Activity Schedule shall not be altered when the Contractor makes such changes to the Activity Schedule.

40. Variations

- 40.1. The Project Manager shall order any variation of the form, quality or quantity of the Works or any part thereof that may, in his opinion, be necessary. Each variation may include, but is not limited to, any of the following:
- (a) increase or decrease in the quantity of any work included in the Contract,
 - (b) omission of any item of work,
 - (c) change in the character or quality or kind of any such work,
 - (d) change in the levels, lines, position and dimensions of any part of the works,
 - (e) additional work of any kind (not exceeding twenty percent (20%) of the initial contract amount, or the maximum threshold value for the use of Limited Tender whichever is lower), or
 - (f) change in any specified sequence or timing of construction activities.
- 40.2. For works upto Nu. 50 Million, if the value of additional work exceeds twenty percent (20%) of the initial contract price, the procuring agency shall seek prior approval of the Competent Authority (Finance Committee constituted in respective agency).
- 40.3. For works above Nu. 50 Million, if the value of additional work exceeds twenty percent (20%) of the initial contract price, the procuring agency shall seek prior approval of the Competent Authority (Public Investment Board/Public Investment Coordination Committee).
- 40.4. The Project Manager shall make any such variation by issuing written instructions to the Contractor and ensure that such variations are duly noted in the Site Order Register. A variation made shall not, in any way, vitiate or invalidate the Contract, but the effect, if any, of all such variations shall be valued in accordance with GCC Clause 41.
- 40.5. The Contractor shall execute and be bound by each Variation, unless the Contractor promptly gives notice to the Project Manager stating (with supporting particulars) that (i) the Contractor cannot readily obtain the Goods required for the Variation, or (ii) such Variation triggers a substantial change in the sequence of the progress of the Works. Upon receiving this notice, the Project Manager shall cancel, confirm or vary the instruction.
- 40.6. All Variations shall be included in updated Programs⁴⁴ produced by the Contractor.

⁴⁴ In lump sum contracts, add "and Activity Schedules" after "Programs".

41. Payments for Variations

41.1. The Contractor shall provide the Project Manager analyzed rate for carrying out the Variation when requested to do so by the Project Manager. The Project Manager shall assess the analyzed rates, which shall be given within seven days of the request or within any longer period stated by the Project Manager and before the Variation is ordered.

41.2. If the work in the Variation corresponds with an item description in the Bill of Quantities and if, in the opinion of Project Manager, the quantity of work above the limit stated in GCC Sub-Clause 39.1 or the timing of its execution do not cause the cost per unit of quantity to change, the rate in the Bill of Quantities shall be used to calculate the value of the Variation. If the cost per unit of quantity changes, or if the nature or timing of the work in the Variation does not correspond with items in the Bill of Quantities, the quotation by the Contractor shall be in the form of new rates for the relevant items of work.⁴⁵

41.3. If the Contractor's quotation is unreasonable, the Project Manager may order the Variation and make a change to the Contract Price, which shall be based on the Project Manager's own forecast of the effects of the Variation on the Contractor's costs.

41.4. If the Project Manager decides that the urgency of varying the work would prevent a quotation being given and considered without delaying the work, no quotation shall be given and the Variation shall be treated as a Compensation Event.

41.5. The Contractor shall not be entitled to additional payment for costs that could have been avoided by giving early warning.

42. Cash Flow Forecasts

42.1. When the Program⁴⁶ is updated, the Contractor shall provide the Project Manager with an updated cash flow forecast. The cash flow forecast shall include different currencies, as defined in the Contract, converted as necessary using the Contract exchange rates.

43. Payment Certificates

43.1. The Contractor shall submit to the Project Manager monthly statements of the value of the work executed, based on the Contractor's records, less the cumulative amount certified previously.

43.2. The Project Manager shall check the Contractor's monthly statement (running account bills) and certify the amount to be paid to the Contractor latest by 30 working days from the date of receipt of contractor's monthly statement in correct and complete form.

⁴⁵ In lump sum contracts, delete this paragraph.

⁴⁶ In lump sum contracts, add "or Activity Schedule" after "Program".

- 43.3. The value of work executed shall be determined by the Project Manager.
- 43.4. The value of work executed shall comprise the value of the quantities of the items in the Bill of Quantities completed⁴⁷ and measurement thereof shall be carried out jointly by the Project Manager, or his Representative, and the Contractor. The Project Manager, or his Representative, shall record the value of the work executed in a measurement book for the purposes of verifying the Contractor's monthly statements. The measurement book shall be signed by the Project Manager or his Representative, and countersigned by the Contractor.
- 43.5. The value of work executed shall include the valuation of Variations and Compensation Events.
- 43.6. The Project Manager may exclude any item certified in a previous certificate or reduce the proportion of any item previously certified in any certificate in the light of later information.

44. Payments

- 44.1. Payments shall be adjusted for deductions for advance payments, taxes, retention money and any other dues. The Employer shall pay the Contractor within 30 working days from the date of receipt of correct and verified bills/invoices in complete form by the Finance Section.
- 44.2. If the Employer makes a late payment, the Contractor shall be paid interest only on the late payment amount in the next payment. Interest shall be calculated from the date by which the payment should have been made up to the date when the late payment is made at the prevailing rate of interest for overdraft facilities availed from respective financial institutes.
- 44.3. If an amount certified is increased in a later certificate or as a result of an award by the Adjudicator or an Arbitrator, the Contractor shall not be paid interest upon the delayed payment as set out in this clause.
- 44.4. Unless otherwise stated, all payments and deductions shall be paid or charged in the proportions of currencies comprising the Contract Price.
- 44.5. Items of the Works for which no rate or price has been entered in shall not be paid for by the Employer and shall be deemed covered by other rates and prices in the Contract.

⁴⁷ In lump sum contracts, replace this paragraph with the following: "The value of work executed shall comprise the value of completed activities in the Activity Schedule."

45. Compensation Events for allowing time extension

45.1. The following shall be Compensation Events allowing for time extension:

- (a) The Employer does not give access to a part of the Site by the Site Possession Date pursuant to GCC Sub-Clause 21.1.
- (b) The Employer modifies the Schedule of Other Contractors in a way that affects the work of the Contractor under the Contract.
- (c) The Project Manager orders a delay or does not issue Drawings, Specifications or instructions required for execution of the Works on time.
- (d) The Project Manager instructs the Contractor to uncover or to carry out additional tests upon work, which is then found to have no Defects.
- (e) The Project Manager unreasonably does not approve a subcontract to be let if provided in SCC.
- (f) The Project Manager gives an instruction for dealing with an unforeseen condition, caused by the Employer, or additional work required for safety or other reasons.
- (g) Other contractors, public authorities, utilities or the Employer do not work within the dates and other constraints stated in the Contract, and they cause delay.
- (h) Other Compensation Events described in the SCC or determined by the Employer and force majeure. "Force Majeure" means an exceptional event or circumstance:
 - (i) which is beyond a Party's control,
 - (ii) which such Party could not reasonably have provided against before entering into the Contract,
 - (iii) which, having arisen, such Party could not reasonably have avoided or overcome, and
 - (iv) which is not substantially attributable to the other Party.

Force Majeure may include, but is not limited to, exceptional events or circumstances of the kind listed below, so long as conditions (i) to (iv) above are satisfied:

- (i) war, hostilities (whether war be declared or not), invasion, act of foreign enemies,
- (ii) rebellion, terrorism, sabotage by persons other than the Contractor's Personnel, revolution, insurrection, military or usurped power, or civil war,
- (iii) riot, commotion, disorder, strike or lockout by persons other than the Contractor's Personnel,
- (iv) munitions of war, explosive materials, ionizing radiation or contamination by radio-activity, except as may be attributable to the Contractor's use of such munitions, explosives, radiation or radio-activity, and
- (v) natural catastrophes such as earthquake, hurricane, typhoon or volcanic activity.

However, force majeure shall not include the following;

- (i) rainfall
- (ii) snowfall
- (iii) strikes in other countries
- (iv) non-availability of laborer and materials such as timbers, boulders, sand, and other materials
- (v) difficulty and risky terrain and remoteness of site

45.2. If a Compensation Event would prevent the work being completed before the Intended Completion Date, the Intended Completion Date shall be extended. The Project Manager shall decide whether and by how much the Intended Completion Date shall be extended.

45.3. The Contractor shall not be entitled to compensation to the extent that the Employer's interests are adversely affected by the Contractor not having given early warning.

46. Tax

46.1. The prices bid by the contractor shall include all duties, taxes and levies that may be levied in accordance with the laws and regulations in being as of the date 30 days prior to the closing date for submission of bids.

47. Currencies

47.1. Where payments are made in currencies other than Ngultrum (Nu), the exchange rates used for calculating the amounts to be paid shall be the exchange rates stated in the Contractor's Bid.

48. Price Adjustment

48.1. If during the contract, there is an increase or decrease in the cost of materials as reflected by the Material Index Numbers published by the National Statistical Bureau⁴⁸ (NSB), a corresponding increase or decrease in the payment to the contractor or recoverable from the Contractor shall be effected on the basis of the following formulae, such calculation being done for every successive period of 3 months after the 12th month of the Contract duration:
Adjustment for variation of material prices:

$$V = W \times 0.80 \times 0.75 \times (M - M_0) / M_0$$

where:

V = amount of variation for materials payable to/recoverable from the contractor for the period under review;

W = value of the work done during the period under review minus (amount of secured advance recovered in the same period + value of works executed under variations for which the variations are paid in the new rate);

M₀ = Material Index for the month in which the tender was submitted;

M = the average value of the above Index Number for the 3 months period under review;

⁴⁸ Until NSB comes up with the Material Index for the Royal Government of Bhutan, the Wholesale Price- Index (all commodities) for Materials shall be used for the purpose of this clause. Visit www.eaindustry.nic.in for the Wholesale Price Index.

48.2. For the applications of the above formulae, the appropriate Index Numbers published by the National Statistical Bureau shall be adopted.

48.3. To the extent that full compensation for any rise or fall in costs to the contractor is not covered by the provisions of this or other clauses in the contract, the unit rates and prices included in the contract shall be deemed to include amounts to cover the contingency of such other rise or fall in costs.

48.4. Price Adjustment shall apply only for work carried out within the stipulated time or extensions granted by the Procuring Agency and shall not apply to work carried out beyond the stipulated time for reasons attributable to the Contractor.

49. Retention

49.1. The Employer shall retain⁴⁹ ten percent (10%) from each payment due to the Contractor in the proportion stated in the SCC until Completion of the whole of the Works as retention money.

49.2. On completion of the whole of the works, half the total amount retained shall be repaid to the Contractor and half when defects liability period has passed and the Engineer has certified that all defects notified by the Engineer to the Contractor before the end of this period have been corrected.

49.3. On completion of the whole of the works, the contractor may substitute the balance half of retention money by an unconditional bank guarantees. In the case of contracts beyond duration of 12 months, substitution of retention money by such a bank guarantee may be allowed on completion of 50% of the value of contract and duly certified by the Project Manager. The bank guarantee shall be valid until the issue of No Defects Liability Certificates by the Project Manager that all defects notified by the Project Manger to the Contractor have been rectified to his satisfaction before the end of this period. If the Contractor fails to remedy any reported defect within the Defect Liability Period, the Employer shall withhold the payment or realize claims from the bank guarantee of an amount which in the opinion of the Employer represents the cost of the defect to be remedied.

50. Liquidated Damages

50.1. The Contractor shall pay liquidated damages to the Employer at the rate per day stated in the SCC for each day that the Completion Date is later than the Intended Completion Date. The total amount of liquidated damages shall not exceed the ten percent (10%) of the Initial Contract Price. The Employer may deduct liquidated damages from payments due to the Contractor. Payment of liquidated damages shall not affect the Contractor's liabilities.

⁴⁹ The retention amount is usually ten percent (10%).

51. Advance Payment

51.1. The Employer shall make advance payment to the Contractor of the amount stated in the SCC (mobilization) by the date stated in the SCC, against provision by the Contractor of an Unconditional Bank Guarantee in a form and by a bank acceptable to the Employer in amounts and currencies equal to the advance payment. The Guarantee shall remain effective until the advance payment has been repaid, but the amount of the Guarantee shall be progressively reduced by the amounts repaid by the Contractor. Interest shall not be charged on the advance payment.

51.2. The secured advances shall be paid to the contractor as specified in SCC on the following conditions:

- (a) The materials shall be in accordance with the specifications and shall not be in excess of the requirements;
- (b) The materials shall be delivered at the site of the works, properly stored and protected against loss, damage or deterioration;
- (c) A declaration shall be given by the contractor passing on the lien on the rights of the materials to the Procuring Agency.
- (d) The amount of the secured advance shall not be more than seventy five percent (75%) of the cost of materials delivered at the site of works which shall be supported by the original invoices/bills from the suppliers. All materials imported from other countries shall be supported by Bhutan Sales Tax Receipts or Customs Clearance. In case of fabrication works off site, secured advance may be paid to the Contractor after site inspection is carried out by the Procuring Agency at the cost of the contractor, submission of proof of payment (work order) and submission of supply order.

The secured advance shall be recovered from the interim progress payments in the months in which these materials are used in the works.

51.3. The Contractor is to use the advance payment only to pay for, Equipments, Plant, Materials and mobilization expenses required specifically for execution of the Contract. The contractor shall demonstrate that advance has been used in this way by supplying copies of invoices or other documents to the project manager. The manager shall encash the advance guarantee if the contractor is in breach of its obligation by using the advance payment for purpose other than the costs of mobilization in respect of the works.

51.4. The advance payment shall be repaid by deducting proportionate amounts from payments otherwise due to the Contractor, following the schedule of completed percentages of the Works on a payment basis. The Mobilization Advance shall be recovered when eighty percent (80%) of the contract is executed. No account shall be taken of the advance payment or its repayment in assessing valuations of work done, Variations, price adjustments, Compensation Events, Bonuses or Liquidated Damages.

52. Securities

- 52.1. The Performance Security shall be provided to the Employer no later than the date specified in the Letter of Acceptance and shall be issued in an amount specified in the SCC by a bank or surety acceptable to the Employer, and denominated in the types and proportions of the currencies in which the Contract Price is payable. The Performance Security shall be valid until a date 30 days from the date of issue of the Certificate of Completion.
- 52.2. Following the successful completion of the Contract, the Employer shall return the Performance Security to the Contractor within 14 days of receipt of the Certificate of Completion.
- 52.3. The Employer shall encash the performance security to avoid it becoming invalid in case of failure by contractor to extend the validity.
- 52.4. The performance security (*including additional performance security obtained under abnormally low pursuant to ITB Clause 31 and seriously unbalanced and/or frontloaded bid pursuant to ITB Clause 32*) shall be payable to the employer as compensation for any loss resulting from the contractor's failure to complete its obligations under the contract.

53. Day works

- 53.1. If applicable, the Day works rates in the Contractor's Bid shall be used for small additional amounts of work only when the Project Manager has given written instructions in advance for additional work to be paid for in that way.
- 53.2. All work to be paid for as Day works shall be recorded by the Contractor on forms approved by the Project Manager. Each completed form shall be verified and signed by the Project Manager within 2 days of the work being done.
- 53.3. The Contractor shall be paid for Day works subject to obtaining signed Day works forms and at the rate quoted for Day works.

54. Cost of Repairs

- 54.1. Loss or damage to the Works or Materials to be incorporated in the Works between the Start Date and the end of the Defects Correction periods shall be remedied by the Contractor at the Contractor's cost if the loss or damage arises from the Contractor's acts or omissions.

E. Completion of the Contract**55. Completion**

- 55.1. The Contractor shall request the Project Manager to issue a Certificate of Completion of the Works, and the Project Manager shall do so upon deciding that the work is completed.
- 55.2. An on-time completion out of a total of thirty percent (30%) scoring shall be done by the Program Manager. The contractor shall be penalized under this component if he fails to deliver the project as per the initial time-lines committed in the Program.

The site engineer shall penalize the contractor to an extent of thirty percent (30%). The quantum of penalty could vary as following:

- (i) Ten (10%) percent for a minor default
(if the final completion of the project is delayed by 10 - 15% as compared to original project duration)
- (ii) Twenty percent (20%) for a medium default
(if the final completion of the project is delayed by 15 - 25% as compared to original project duration)
- (iii) Thirty percent (30%) for a major default
(if the final completion of the project is delayed by 25% or more as compared to original project duration)

55.3. At the time of taking over the work, the project Manager shall ensure that the contractor constructs a permanent information board as specified in SCC:

56. Taking Over

56.1. The Employer shall take over the Site and the Works and shall issue the completion Certificate within 7 days of taking over. The completion certificate shall include the following mandatory information:

- (i) Name of Contract firm
- (ii) Name of Proprietor
- (iii) CDB Registration No.
- (iv) Trade License No.
- (v) Contract Amount
- (vi) Year of Completion
- (vii) Award order No. with Date.

57. Final Account

57.1. The Contractor shall supply the Project Manager with a detailed account of the total amount that the Contractor considers payable under the Contract before the end of the Defects Liability Period. The Project Manager shall issue a Defects Liability Certificate and certify any final payment that is due to the Contractor within 30 days of receiving the Contractor's account if it is correct and complete. If it is not, the Project Manager shall issue within 30 days a schedule that states the scope of the corrections or additions that are necessary. If the Final Account is still unsatisfactory after it has been resubmitted, the Project Manager shall decide on the amount payable to the Contractor and issue a payment certificate.

58. Operating and Maintenance Manuals

58.1. If "as built" Drawings and/or operating and maintenance manuals are required, the Contractor shall supply them by the dates stated in the SCC.

58.2. If the Contractor does not supply the Drawings and/or manuals by the dates stated in the SCC, or they do not receive the Project Manager's approval, the Project Manager shall withhold the amount stated in the SCC from payments due to the Contractor.

59. Termination

- 59.1. The Employer or the Contractor may terminate the Contract if the other party causes a fundamental breach of the Contract.
- 59.2. Fundamental breaches of Contract shall include, but shall not be limited to, the following:
- (a) the Contractor stops work for 30 days when no stoppage of work is shown on the current Program and the stoppage has not been authorized by the Project Manager;
 - (b) the Project Manager instructs the Contractor to delay the progress of the Works, and the instruction is not withdrawn within 30 days;
 - (c) the Employer or the Contractor is made bankrupt or goes into liquidation other than for a reconstruction or amalgamation;
 - (d) The Contractor fails to employ the personnel and equipments proposed pursuant to GCC clause 10.1,
 - (e) a payment certified by the Project Manager is not paid by the Employer to the Contractor within 84 days of the date of the Project Manager's certificate;
 - (f) the Project Manager gives notice that failure to correct a particular Defect is a fundamental breach of Contract and the Contractor fails to correct it within a reasonable period of time determined by the Project Manager;
 - (g) the Contractor does not maintain a security, which is required;
 - (h) the Contractor subcontracts any or whole of the Works without the approval of the Employer;
 - (i) the Contractor has delayed the completion of the Works by the number of days for which the maximum amount of liquidated damages can be paid, as defined in the SCC; and
 - (j) in case of joint venture any or all parties fail to fulfill the contractual obligations.
 - (k) Fails to execute the contract in accordance with the contract, such failure being defined in SCC;
 - (l) refuses or is unable to execute and complete the Works and Services in the manner specified in the program furnished under GC Clause 27 at rates of progress that give reasonable assurance to the Employer that the Contractor can attain completion of the works and services by the Time for Completion as extended.

For fundamental breach of contract by contractor the employer shall give notice of a breach of contract for causes listed under GCC sub-clause 59.2 above and requiring the contractor to remedy the same. If the Contractor fails to remedy or to take steps to remedy the same within fifteen (15) days of its receipt of such notice, then the Employer may terminate the Contract forthwith by giving a notice of termination to the Contractor that refers to this GC Sub-Clause 59.2.

For fundamental breach of contract by employer the Contractor shall give a notice to the Employer thereof to remedy the breach within thirty (30) days of such notice and if the Employer is still unable to carry out any of its obligations under the Contract for any reason attributable to the Employer within thirty (30) days of the said notice, the Contractor may by a further notice to the Employer referring to this GC Sub-Clause 59.2, forthwith terminate the Contract.

59.3. When either party to the Contract gives notice of a breach of Contract to the Project Manager for a cause other than those listed under GCC Sub-Clause 59.2 above, the Project Manager shall decide whether the breach is fundamental or not.

59.4. Notwithstanding the above, the Employer may terminate the Contract for convenience.

59.5. If the Contract is terminated, the Contractor shall stop work immediately, make the Site safe and secure, and leave the Site as soon as reasonably possible.

60. Corrupt or Fraudulent Practices

60.1. If the Employer determines that the Contractor has engaged in corrupt, fraudulent, collusive, coercive or obstructive practices in competing for or in executing the Contract then the Employer may, after giving 14 days notice to the Contractor, terminate the Contractor's employment under the Contract and expel him from the Site, and the provisions of GCC Sub-Clause 60.4 to 60.8 shall apply.

60.2. Should any employee of the Contractor be determined to have engaged in corrupt, fraudulent, collusive, coercive or obstructive practice during the execution of the Works, then that employee shall be removed in accordance with GCC Sub-Clause 10.2

60.3. For the purposes of this Sub-Clause:

- (a) "corrupt practice"⁵⁰ is the offering, giving, receiving or soliciting, directly or indirectly, of anything of value⁵¹ to influence improperly the actions of another party;
- (b) "fraudulent practice"⁵² is any act or omission, including a misrepresentation, that knowingly or recklessly misleads, or attempts to mislead, a party to obtain a financial or other benefit or to avoid an obligation;

⁵⁰ "another party" refers to a public official acting in relation to the procurement process or contract execution. In this context, "public official" includes staff and employees of other organizations (including any institutions providing finance for the Works) taking or reviewing procurement decisions.

⁵¹ "anything of value" includes, but is not limited to, any gift, loan, fee, commission, valuable security or other asset or interest in an asset; any office, employment or contract; any payment, discharge or liquidation of any loan, obligation or other liability whatsoever, whether in whole or in part; any other services, favour or advantage, including protection from any penalty or disability incurred or apprehended or from any action or proceeding of a disciplinary or penal nature, whether or not already instituted and including the exercise or the forbearance from the exercise of any right or any official power or duty.

⁵² a "party" refers to a public official; the terms "benefit" and "obligation" relate to the procurement process or contract execution; and the "act or omission" is intended to influence the procurement process or contract execution.

Section VI. General Conditions of Contract (GCC)

- (c) “collusive practice”⁵³ is an arrangement between two or more parties designed to achieve an improper purpose, including to influence improperly the actions of another party;
- (d) “coercive practice”⁵⁴ is impairing or harming, or threatening to impair or harm, directly or indirectly, any party or the property of the party to influence improperly the actions of a party;
- (e) “obstructive practice” is
 - ⓐ deliberately destroying, falsifying, altering or concealing of evidence material to the investigation or making false statements to investigators in order materially to impede any investigation into allegations of a corrupt, fraudulent, coercive or collusive practice; and/or threatening, harassing or intimidating any party to prevent it from disclosing its knowledge of matters relevant to the investigation or from pursuing the investigation; or
 - ⓑ acts intended materially to impede the exercise of the inspection and audit rights of the Employer and/or any other relevant RGoB agency provided for under GCC Clause 23.

60.4. will reject a proposal for award if it determines that the Bidder recommended for award has, directly or through an agent, engaged in corrupt, fraudulent, collusive, coercive or obstructive practices in competing for the contract in question;

60.5. will sanction a firm or individual, including declaring them ineligible, either indefinitely or for a stated period of time, to be awarded an RGoB-financed contract if it at any time determines that they have, directly or through an agent, engaged in corrupt, fraudulent, collusive, coercive or obstructive practices in competing for, or in executing, an RGoB-financed contract;

60.6. Will have the right to require that a provision be included in Bidding Documents and in contracts financed by the RGoB, requiring Bidders, Suppliers, Contractors and their Subcontractors to permit the Purchaser, any organization or person appointed by the Purchaser and/or any relevant RGoB agency to inspect their accounts and records and other documents relating to their Bid submission and contract performance and to have them audited by auditors appointed by the Purchaser;

60.7. Requires that Bidders, as a condition of admission to eligibility, execute and attach to their bids an Integrity Pact Statement in the form provided in the Bidding Documents which shall also be signed by procuring agencies; and

⁵³ “parties” refers to participants in the procurement process (including public officials) and an “improper purpose” includes attempting to establish bid prices at artificial, non competitive levels.

⁵⁴ a “party” refers to a participant in the procurement process or contract execution.

60.8. Will report any case of corrupt, fraudulent, collusive, coercive or obstructive practice to the relevant RGoB agencies, including but not limited to the Anti-Corruption Commission (ACC) of Bhutan, for necessary action in accordance with the statutes and provisions of the relevant agency.

61. Payment upon Termination

61.1. If the Contract is terminated because of a fundamental breach of Contract by the Contractor, the Project Manager shall issue a certificate for the value of the work done and Materials ordered less advance payments received up to the date of the issue of the certificate and less the percentage to apply to the value of work not completed, as indicated in the SCC. If the total amount due to the Employer exceeds any payment due to the Contractor, the difference shall be a debt payable by the Contractor to the Employer.

61.2. If the Contract is terminated for the Employer's convenience or because of a fundamental breach of Contract by the Employer, the Project Manager shall issue a certificate for the value of the work done, Materials ordered, the reasonable cost of removal of Equipment, repatriation of the Contractor's personnel employed solely on the Works, and the Contractor's costs of protecting and securing the Works, and less advance payments received up to the date of the certificate.

62. Property

62.1. All materials on the Site, Plant, Equipment, Temporary Works and Works are deemed to be the property of the Employer if the contract is terminated because of a Contractor's default.

63. Release from Performance

63.1. If the Contract is frustrated by the outbreak of war or by any other event entirely outside the control of either the Employer or the Contractor, the Project Manager shall certify that the Contract has been frustrated. The Contractor shall make the Site safe and stop work as quickly as possible after receiving this certificate and shall be paid for all work carried out before receiving it and for any work carried out afterwards to which a commitment was made.

SECTION VII. SPECIAL CONDITIONS OF CONTRACT

Except where otherwise indicated, all SCC should be filled in by the Employer prior to issuance of the Bidding Documents. Schedules and reports to be provided by the Employer should be annexed.

A. General	
GCC 1.1 (o)	The Employer is [<i>Chhukha Dzongkhag Administration</i>].
GCC 1.1 (r)	The Intended Completion Date for the whole of the Works shall be [<i>10 months</i>]
GCC 1.1 (v)	The Project Engineer is <i>Sangay Pelden, AE</i>
GCC 1.1 (y)	The Site is located at <i>Gedu</i> and is defined in Drawings
GCC 1.1 (bb)	The Start Date shall be
GCC 1.1 (ff)	The Works consist of <i>Construction of Farmers Outlet at Gedu</i>
GCC 2.2	Sectional Completions are:
GCC 2.3 (9)	The following documents also form part of the Contract: <i>Schedule of Other Contractors (GCC 9)</i> <i>Schedule of Key Personnel (GCC 10)</i> <i>Site Investigation Reports (GCC 11)</i> <i>Schedule of Operating and Maintenance Manuals (GCC 57)</i>
GCC 3.1	The language of the contract is <i>English</i> The law that applies to the Contract is the law of the Kingdom of Bhutan.
GCC 9.1	Schedule of other contractors:
GCC 10.1	Key Personnel: The amount to be deducted for the key personnel not employed by the contractor for each personnel is <i>Nu.25000 for each personnel per month</i> The amount to be deducted for the equipments not available at site is <i>hiring charges of the equipments]</i> The amount to be deducted for the Bhutanese Employment not employed by the contractor for each personnel is <i>Nu.9000 for each personnel per month</i>

GCC 14.1	The minimum insurance amounts and deductibles shall be: (a) loss of or damage to the Works, Plant and Materials to be built into the works: <i>insurance should be done at your own risk</i>
GCC 15.1	Queries. The site engineer shall clarify queries on SCC
GCC 21.1	The Site Possession Date(s) shall be: <i>within 7 days after issuance of work order</i>
GCC 21.2	The information board shall be 1.2m*1m made of marble attached to wall of building and as per the instruction of site Engineer with following details: (i) Name of Work: (ii) Start and Completion Date: (iii) Value of Work: (iv) Name of Contractor: (v) Name of Employer:
GCC 25.2	Fees and types of reimbursable expenses to be paid to the Adjudicator: <i>As per the existing rules</i>
GCC 25.3	Institution whose arbitration procedures shall be used from Bhutan For Contracts with Bhutanese Contractors Bhutan Alternative Dispute Resolution Centre (BADRC); GCC Sub-Clause 24.3—All disputes arising in connection with the present Contract shall be finally resolved by arbitration in accordance with the rules and procedures of the Bhutan Alternative Dispute Resolution Centre (BADRC). The arbitration award shall be final on the parties who shall be deemed to have accepted to carry out the resulting award without delay and to have waived their right to any form of appeal insofar as such waiver can validly be made.

B. Time Control	
GCC 27.1	<p>The Contractor shall submit for approval a Program for the Works within <i>15 days</i> Days from the date of the Letter of Acceptance.</p> <p>The Program shall include, but not be limited to, the following elements under the conditions stipulated:</p> <p>(a) Quality Assurance Plan (QAP)</p> <p>The Quality Assurance Plan shall specify the work methodology, quality control tests and intervals for such tests in accordance with the work specifications for each item of the Works. If in the opinion of the Project Manager the QAP submitted by the Contractor does not fully represent the spirit of the General Conditions of Contract or the Specifications he may seek further clarification from the Contractor before his approval. The Contractor shall strictly follow the QAP in the execution of the Works. If the Contractor does not comply with the QAP, he shall not be allowed to proceed further with the Works. Details of all procedures and compliance documents shall be submitted to the Project Manager for information before each execution stage is commenced. Compliance with the quality assurance system shall not relieve the Contractor of any of his duties, obligations or responsibilities under the contract.</p>
GCC 27.3	<p>The period between Program updates is <i>[90]</i> days.</p> <p>The amount to be withheld for late submission of an updated Program is Nu.100000</p>

C. Quality Control	
GCC 36.1	The Defects Liability Period is: <i>12 months</i>
D. Cost Control	
GCC 45.1 (h)	Other Compensation Events are: none
GCC 46.1	In case of certain Tax exemptions, such as in foreign assistance projects, this specific exemption(s) should be clearly specified in this clause.
GCC 48.1	The Contract <i>is not</i> subject to price adjustment in accordance with GCC Clause 48.
GCC 49.1	The proportion of payments retained is: <i>10% of final contract amount</i>
GCC 50.1	The liquidated damages for the whole of the Works are <i>0.075% of initial contract amount</i> per day up to maximum of 10% of initial contract amount
GCC 51.1	The Mobilization Advance Payment shall be ten percent (10%) of the Contract Price and shall be paid to the Contractor no later than 30 days after receipt by the Employer of an acceptable Advance Payment Guarantee.
GCC 51.2	The secured advance is 75% of material brought at site
GCC 52.1	The Performance Security amount is 10% of contract amount
D. Finishing the Contract	
55.3	The permanent information board shall be of 1.2m*1m made of marble attached to wall of building and as per the instruction of site Engineer with following details: <ul style="list-style-type: none"> (i) Name of Work: (ii) Completion Year: (iii) Constructed by: (iv) Name of Employer:

GCC 58.1	The date by which operating and maintenance manuals are required is <i>during the time of Handing taking</i>
GCC 58.2	The amount to be withheld for failing to produce “as built” drawings and/or operating and maintenance manuals by the date required in GCC Sub-Clause 58.1, or failing to obtain the Project Manager’s approval of them by the said date, is <i>Nu.100,000</i>
GCC 59.2 (i)	The maximum number of days is: 133 days
GCC 59.2 (k)	Failure to execute contract in accordance with clause and contract terms and condition the contract shall be terminated
GCC 61.1	The percentage to apply to the value of the work not completed, representing the Employer’s additional cost for completing the Works, is 20%of value of work not done up to maximum of 10% of initial contract amount

SECTION VIII SPECIFICATIONS AND PERFORMANCE REQUIREMENTS

Notes on Specifications and Performance Requirements

A set of precise and clear Specifications is a prerequisite for Bidders to respond realistically and competitively to the requirements of the Employer without qualifying or conditioning their Bids. In the context of international competitive bidding, the Specifications must be drafted to permit the widest possible competition and, at the same time, present a clear statement of the required standards of workmanship, materials and performance of the Works to be procured. Only if this is done will the objectives of economy, efficiency and fairness in procurement be realized, responsiveness of Bids be ensured, and the subsequent task of Bid evaluation facilitated. The Specifications should require that all goods and materials to be incorporated in the Works be new, unused, of the most recent or current models, and incorporate all recent improvements in design and materials unless provided otherwise in the Contract.

Samples of Specifications from previous similar projects are useful in this respect. Most specifications are normally written specially by the Employer or Project Manager to suit the Contract Works in hand. There is no standard set of Specifications for universal application in all sectors but there are established principles and practices, which are reflected in these documents.

There are considerable advantages in standardizing General Specifications for repetitive Works in recognized public sectors such as highways, ports, railways, urban housing, irrigation and water supply, especially in the same region where similar conditions prevail. The General Specifications should cover all classes of workmanship, materials and equipment commonly involved in construction, although not necessarily to be used in a particular Works Contract. Deletions or addenda should then adapt the General Specifications to the particular Works.

Care must be taken in drafting Specifications to ensure that they are not restrictive. In the specification of standards for goods, materials and workmanship recognized international standards should be used as much as possible. Where other particular standards are used, whether national standards or other standards, the Specifications should state that goods, materials and workmanship that meet other authoritative standards, and which ensure substantially equal or higher quality than the standards mentioned, will also be acceptable. To this effect, the following clause may be inserted in the Special Conditions or Specifications.

“Equivalency of Standards and Codes

Wherever reference is made in the Contract to specific standards and codes to be met by the goods and materials to be furnished, and work performed or tested, the provisions of the latest current edition or revision of the relevant standards and codes in effect shall apply, unless otherwise expressly stated in the Contract. Where such standards and codes are national or regional, other authoritative standards that ensure a substantially equal or higher quality than the standards and codes specified will be accepted subject to the Project Manager’s prior review and written consent. Differences between the standards specified and the proposed alternative standards shall be fully described in writing by the Contractor and submitted to the Project Manager at least 30 days prior to the date when the Contractor desires the Project Manager’s consent. In the event the Project Manager determines that such proposed deviations do not ensure substantially equal or higher quality, the Contractor shall comply with the standards specified in the documents.”

These Notes for Preparing Specifications are intended only as information for the Employer or the person drafting the Bidding Documents. They should not be included in the final documents.

SECTION IX. DRAWINGS



SECTION X. CONTRACT FORMS

Notes on Forms of Securities

*This Section contains forms which, once completed, will form part of the Contract. The forms for **Performance Security** and **Advance Payment Security**, when required, shall only be completed by the successful Bidder after Contract award.*

TABLE OF FORMS

Letter of Acceptance	92
Contract	93
Performance Demand Bank Guarantee	94
Bank Guarantee for Advance Payment	95
Retention Money Security Demand Guarantee	96

Letter of Acceptance

[Letterhead paper of the Employer]

Notes on Standard Form of Letter of Acceptance

The Letter of Acceptance shall be the basis for formation of the Contract as described in ITB Clauses 37 of the Instructions to Bidders. This Standard Form of Letter of Acceptance shall be filled in and sent to the successful Bidder only after evaluation of Bids has been completed.

[Insert date]

To: *[name and address of the Contractor]*

This is to notify you that your Bid dated *[insert date]* for execution of the *[insert name of the Contract and identification number, as given in the SCC]* for the Contract Price of the equivalent⁵⁵ of *[insert amount in numbers and words] [insert name of currency]*, as corrected and modified⁵⁶ in accordance with the Instructions to Bidders is hereby accepted by our Agency.

[Insert one of the following (x) or (y) options if applicable]

- (x) We accept that *[insert name proposed by Bidder]* be appointed as the Adjudicator.⁵⁷
- (y) We do not accept that *[insert name proposed by Bidder]* be appointed as Adjudicator, and by sending a copy of this Letter of Acceptance to *[insert name of the Appointing Authority]* we are hereby requesting *[insert name]*, the Appointing Authority, to appoint the Adjudicator in accordance with ITB Clause 41.⁵⁸

The Contract in duplicate is attached hereto. You are hereby instructed to:

- (a) confirm your acceptance of this Letter of Acceptance by signing and dating both copies of it, and returning one copy to us no later than 15 days from the date hereof;
- (b) proceed with the execution of the said Works in accordance with the Contract;
- (c) sign and date both copies of the attached Contract and return one copy to us within 15 days of the date hereof; and
- (d) forward the Performance Security pursuant to ITB Sub-Clause 39.1, i.e., within 15 days after receipt of this Letter of Acceptance, and pursuant to GCC Sub-Clause 52.1

Authorized Signature: _____

Name and Title of Signatory: _____

Name of Agency: _____

Attachment: Contract

⁵⁵ Delete "of the equivalent" if the Contract Price is expressed wholly in one currency.

⁵⁶ Delete "corrected and", or "and modified" or "as corrected and modified" as applicable. See Notes on Standard Form of Contract, next page.

⁵⁷ To be used only if the Contractor disagrees in the Bid with the Adjudicator proposed by the Employer in the Instructions to Bidders, and has accordingly offered another candidate who is acceptable to the Employer.

⁵⁸ To be used only if the Contractor disagrees in the Bid with the Adjudicator proposed by the Employer in the ITB, has accordingly offered another candidate, and the Employer does not accept the counterproposal.

Contract

Notes on Standard Form of Contract

The Contract should incorporate any corrections or modifications to the Bid resulting from corrections of errors (ITB Clause 27), price adjustment during the evaluation process (ITB Sub-Clause 15.3), selection of an alternative offer (ITB Clause 16), acceptable deviations (ITB Clause 26), or any other mutually-agreeable changes allowed for in the Special Conditions of Contract, such as changes in key personnel, subcontractors, scheduling, and the like.

This Contract is made the *[insert day]* day of *[insert month]*, *[insert year]* between *[insert name and address of Employer]* (hereinafter called "the Employer") and *[insert name and address of Contractor]* (hereinafter called "the Contractor") of the other part.

Whereas the Employer is desirous that the Contractor execute *[name and identification number of Contract]* (hereinafter called "the Works") and the Employer has accepted the Bid by the Contractor for the execution and completion of such Works and the remedying of any defects therein.

Now this Contract witnesseth as follows:

1. In this Contract, words and expressions shall have the same meanings as are respectively assigned to them in the General Conditions of Contract hereinafter referred to, and they shall be deemed to form and be read and construed as part of this Contract.
2. In consideration of the payments to be made by the Employer to the Contractor as hereinafter mentioned, the Contractor hereby covenants with the Employer to execute and complete the Works and remedy any defects therein in conformity in all respects with the provisions of the Contract.
3. The Employer hereby covenants to pay the Contractor in consideration of the execution and completion of the Works and the remedying of defects therein, the Contract Price or such other sum as may become payable under the provisions of the Contract at the times and in the manner prescribed by the Contract.

In Witness whereof the parties thereto have caused this Contract to be executed the day and year first before written.

The Common Seal of *[Witness entity]* _____

was hereunto affixed in the presence of: _____

Signed, Sealed, and Delivered by the said _____

in the presence of: _____

Binding Signature of Employer *[signature of an authorized representative of the Employer]*

Binding Signature of Contractor *[signature of an authorized representative of the Contractor]*

Performance Demand Bank Guarantee
(Unconditional)

[The **bank/successful Bidder** providing the Guarantee shall fill in this form in accordance with the instructions indicated in brackets.]

[bank's name, and address of issuing branch or office]

Beneficiary: *[name and address of Employer]*

Date: *[date]*

PERFORMANCE GUARANTEE No.: *[Performance Guarantee number]*

We have been informed that *[name of Contractor]* (hereinafter called "the Contractor") has entered into Contract No. *[reference number of the Contract]* dated *[date of Contract]* with you, for the execution of *[name of Contract and brief description of Works]* (hereinafter called "the Contract").

Furthermore, we understand that, according to the conditions of the Contract, a performance guarantee is required.

At the request of the Contractor, we *[name of Bank]* hereby irrevocably undertake to pay you any sum or sums not exceeding in total an amount of *[amount in figures] ([amount in words])*,⁵⁹ such sum being payable in the types and proportions of currencies in which the Contract Price is payable, upon receipt by us of your first demand in writing accompanied by a written statement stating that the Contractor is in breach of its obligation(s) under the Contract, without you needing to prove or to show grounds for your demand or the sum specified therein.

This guarantee shall expire no later than 30 days from the date of issuance of the Certificate of Completion, calculated based on a copy of such Certificate which shall be provided to us, or on the *[number]* day of *[month]*, *[year]*,⁶⁰ whichever occurs first. Consequently, any demand for payment under this guarantee must be received by us at this office on or before that date. The Guarantor agrees to a one-time extension of this Guarantee for a period not to exceed *[6 months][1 year]*, in response to the Employer's written request for such extension, such request to be presented to the Guarantor before the expiry of the Guarantee.

[signature(s) of an authorized representative(s) of the bank]

⁵⁹ The Guarantor (bank) shall insert an amount representing the percentage of the Contract Price specified in the Contract and denominated either in the currency(ies) of the Contract or a freely convertible currency acceptable to the Employer.

⁶⁰ Insert the date 30 days after the expected Completion date. The Employer should note that in the event of an extension of the time for completion of the Contract, the Employer would need to request an extension of this Guarantee from the Guarantor. Such request must be in writing and must be made prior to the expiration date established in the Guarantee.

Bank Guarantee for Advance Payment

The **bank/successful Bidder** providing the Guarantee shall fill in this form in accordance with the instructions indicated in brackets.

[bank's name, and address of issuing branch or office]

Beneficiary: *[name and address of Employer]*

Date: *[date]*

ADVANCE PAYMENT GUARANTEE No.: *[number]*

We have been informed that *[name of Contractor]* (hereinafter called "the Contractor") has entered into Contract No. *[reference number of the contract]* dated *[date of Contract]* with you, for the execution of *[name of contract and brief description of Works]* (hereinafter called "the Contract").

Furthermore, we understand that, according to the conditions of the Contract, an advance payment is to be made against an advance payment guarantee in the sum or sums indicated below.

At the request of the Contractor, we *[name of Bank]* hereby irrevocably undertake to pay you any sum or sums not exceeding in total an amount of *[amount in figures]* (*[amount in words]*⁶¹) upon receipt by us of your first demand in writing accompanied by a written statement stating that the Contractor is in breach of its obligation under the Contract because the Contractor used the Advance Payment for purposes other than the costs of mobilization in respect of the Works.

It is a condition for any claim and payment under this guarantee to be made that the Advance Payment referred to above must have been received by the Contractor in its account number *[account number]* at *[name and address of Bank]*.

The maximum amount of this guarantee shall be progressively reduced by the amount of the Advance Payment repaid by the Contractor as indicated in copies of interim statements or payment certificates which shall be presented to us. This guarantee shall expire, at the latest, upon our receipt of a copy of the Interim Payment Certificate indicating that eighty percent (80%) of the Contract Price has been certified for payment, or on the *[number]* day of *[month]*, *[year]*,⁶² whichever is earlier. Consequently, any demand for payment under this guarantee must be received by us at this office on or before that date. We agree to a one-time extension of this guarantee for a period not to exceed *[6 months][1 year]*, in response to the Employer's written request for such extension, such request to be presented to us before the expiry of the guarantee.

[insert signature(s) of authorized representative(s) of bank]

⁶¹ The Guarantor shall insert an amount representing the amount of the Advance Payment and denominated either in the currency(ies) of the Advance Payment as specified in the Contract, or in a freely convertible currency acceptable to the Employer.

⁶² Insert the expected expiration date of the Time For Completion. The Employer should note that in the event of an extension of the Time For Completion of the Contract, the Employer would need to request an extension of this guarantee from the Guarantor. Such request must be in writing and must be made prior to the expiration date established in the guarantee.

**Retention Money Security
Demand Guarantee**

[bank's name and address of issuing branch or office]

Beneficiary: _____ *[Insert name and Address of Employer]*

Date: _____ *[Insert date of issue]*

RETENTION MONEY GUARANTEE No.: *[Insert guarantee reference number]*

We have been informed that _____ *[insert name of Contractor]* (hereinafter called "the Contractor") has entered into Contract No. _____ *[insert reference number of the contract]* dated _____ with the Beneficiary, for the execution of _____ *[insert name of contract and brief description of Works]* (hereinafter called "the Contract").

Furthermore, we understand that, according to the conditions of the Contract, the Beneficiary retains moneys up to the limit set forth in the Contract ("the Retention Money"), and that when the Taking-Over Certificate has been issued under the Contract and the first half of the Retention Money has been certified for payment, payment of *[insert the second half of the Retention Money or if contract duration is beyond 12 months the amount on completion of 50% of the value of the contract and duly certified by the Project Manager]* is to be made against a Retention Money guarantee.

the amount guaranteed under the Performance Guarantee when the Taking-Over Certificate is issued is less than half of the Retention Money, the difference between half of the Retention Money and the amount guaranteed under the Performance Security] is to be made against a Retention Money guarantee.

At the request of the Applicant, we, as Guarantor, hereby irrevocably undertake to pay the Beneficiary any sum or sums not exceeding in total an amount of _____ *[insert amount in figures]* (_____) *[amount in words]*⁶³ upon receipt by us of the Beneficiary's complying demand supported by the Beneficiary's statement, whether in the demand itself or in a separate signed document accompanying or identifying the demand, stating that the Applicant is in breach of its obligation(s) under the Contract, without your needing to prove or show grounds for your demand or the sum specified therein.

A demand under this guarantee may be presented as from the presentation to the Guarantor of a certificate from the Beneficiary's bank stating that the second half of the Retention Money as referred to above has been credited to the Applicant on its account number _____ at _____ *[insert name and address of Applicant's bank]*.

⁶³ The Guarantor shall insert an amount representing the amount of the second half of the Retention Money or if the amount guaranteed under the Performance Guarantee when the Taking-Over Certificate is issued is less than half of the Retention Money, the difference between half of the Retention Money and the amount guaranteed under the Performance Security and denominated either in the currency(ies) of the second half of the Retention Money as specified in the Contract, or in a freely convertible currency acceptable to the Beneficiary.

This guarantee shall expire no later than the Day of, 2...⁶⁴, and any demand for payment under it must be received by us at the office indicated above on or before that date.

[signature(s)]

Note: All italicized text (including footnotes) is for use in preparing this form and shall be deleted from the final product.

⁶⁴ Insert the same expiry date as set forth in the performance security, representing the date twenty-eight days after the completion date described in GC Clause 11.9. The Employer should note that in the event of an extension of this date for completion of the Contract, the Employer would need to request an extension of this guarantee from the Guarantor. Such request must be in writing and must be made prior to the expiration date established in the guarantee. In preparing this guarantee, the Employer might consider adding the following text to the form, at the end of the penultimate paragraph: "The Guarantor agrees to a one-time extension of this guarantee for a period not to exceed [six months][one year], in response to the Beneficiary's written request for such extension, such request to be presented to the Guarantor before the expiry of the guarantee."

Name of work: Construction of Farmers Outlet at Gedu under Chhukha Dzongkhag

Place of work: Gedu

Title: BoQ

sl.no	BSR ref	Description	Qty	Unit	Rate in fig	Rate in Words	Amount
SUB - STRUCTURES							
1	EW0001	Surface dressing of ground, incl. rem. of veg. and inequalities <150mm deep, disp. of rubbish within 50m lead and 1.5m lifts: Ordinary soil	312	Sq.m			
2	EW0105	Excavation in foundation trenches or drains not exceeding 1.5 in width or area 10 sq.m on plan incl. dressing & ramming, disp. of surplus soil within 50m lead & 1.5m lift: Ordinary Soil	182.46	Cu.m			
3	SM0072	Providing and laying hand packed stone soling or filling with stones .	52.32	Cu.m			
4	CW0005	Providing and laying in position plain cement concrete excluding the cost of centering and shuttering: All work upto plinth level. 1:3:6 (1 cement:3 sand:6 graded crushed rock 20mm nominal size)	32.45	Cu.m			
5	EW0197	Proving & laying dry earth bedding, including consolidating each deposited layer by watering, ramming & dressing.	21.4	Cu.m			
6	RC0002	Providing and laying reinforced cement concrete excluding the cost of cenetering, shuttering and reinforcement - all work upto plinth level: 1:1.5:3 (1 cement : 1.5 sand : 3 graded crushed rock 20 mm nominal size)	14.74	Cu.m			
7	SM0006	Providing & laying Random Rubble Masonry with hard stone in found'n & plinth: In cement mortar 1:5	163.1	Cu.m			
8	EW0195	Filling of trenches, sides of foundations etc in layers <200mm using selected excavated earth, ramming etc within lead 50m & lift 1.5m.	60.82	Cu.m			
SUPER STRUCTURES, RCC							

9	RC0010	Providing and laying in position reinforced cement concrete work in plinth and skirting courses, fillets, columns, pillars, posts and struts upto floor five level excluding the cost of centering, shuttering and reinforcement: 1:1.5:3 (1 cement : 1.5 sand : 3 graded crushed rock 20 mm nominal size)	11.82	Cu.m		
10	RC0018	Providing and laying in position reinforced cement concrete work in beams, lintels, bands, plain window sills, staircases, spiral staircases upto upto floor five level excluding the cost of centering, shuttering and reinforcement: 1:1.5:3 (1 cement : 1.5 sand : 3 graded crushed rock 20 mm nominal size)	21.5	Cu.m		1
11	BW0040	Providing & laying second class brick work in Bhutan type Traditional Cornices in cement mortar 1:3, including 12mm plaster in cement mortar 1:5, but excluding decorative painting.-including phana	34.8			
12	RC0014	Providing and laying in position reinforced cement concrete work in suspended floor, roofs having slope upto 15 ⁰ , landings, balconies, shelves and chajjas upto upto floor five level excluding the cost of centering, shuttering and reinforcement: 1:1.5:3 (1 cement : 1.5 sand : 3 graded crushed rock 20 mm nominal size)	29.58	Cu.m		
13	RC0083	Providing & fixing Thermo-Mechanically Treated reinforcement bar (Yield Strength 500MPa) for R.C.C work including cutting, bending, binding, and placing in position complete	9918.83	Kg		7.5
14	RC0090	Providing & fixing centering and shuttering (formwork), including strutting, propping etc. and removal of formwork: Foundation and plinth etc.	62.1	Sq.m		

15	RC0093	Providing & fixing centering and shuttering (formwork), including strutting, propping etc. and removal of formwork: Columns, Pillars, post, struts etc.	193.2	Sq.m		
16	RC0092	Providing & fixing centering and shuttering (formwork), including strutting, propping etc. and removal of formwork: Lintels, beams, girders, bressumers, cantilevers etc.	397.29	Sq.m		
17	RC0095	Providing & fixing centering and shuttering (formwork), including strutting, propping etc. and removal of formwork: Suspended floor, roof, landing, shelves and their supports, balconies, chajjas, etc.	638.04	Sq.m		
		BRICK MASONRY				
18	BW0147	Providing & laying concrete block brick in Foundation & Plinth - In cement mortar 1:5	35.42	Cu.m		
19	BW0199	Providing & laying Concrete Solid Block Masonry (115 mm) in superstructure below floor 2 level - In cement mortar 1:4	81.92	Sq.m		
20	FL0051	C o n c r e t e F l o o r i n g Pal cement concrete flooring 1:2:4, finished with floating coat of neat cement- 20mm aggregates, 40mm thick	218.5	sq.m		
21	FL0130	Providing & laying Cement plaster skirting < 300mm height with cement mortar 1:3 with a floating coat of neat cement including rounding off junctions with floor-20mm	19.5	sq.m		
22	GL0009	Providing & fixing white/ coloured glazed tiles in flooring, treads of steps and landings laid on bed of 12mm thick cement mortar 1:3 finished with flush pointing in white cement: for 300 x 300 mm	188.69	sq.m		

		CEILING AND WOOD WORKS				
23	WW0132	Providing & fixing Plywood lining with necessary nails etc. including beading complete (excluding cost of frame) : 6mm commercial	252.96	Sq.m		
24	WW0165	Providing & fixing split Bamboo matting (excluding the cost of framing and beading)	70.89	sq.m		
25	WW0021	Providing & fixing joists, including hoisting, applying wood preservative on unexposed surfaces Mixed Conifer	7.74	cu.m		
26	WW0003	Providing & fixing in position dressed wood work frames and 35mm thick panalled or glazed shhutter complete including fittings and hinges as per drawing and directive of site engineer window type W1	2	each		
27	WW0003	Providing & fixing in position dressed wood work frames and 35mm thick panalled or glazed shhutter complete including fittings and hinges as per drawing and directive of site engineer window type W2	3	each		
28	WW0003	Providing & fixing in position dressed wood work frames and 35mm thick panalled or glazed shhutter complete including fittings and hinges as per drawing and directive of site engineer window type W3	4	each		
29	WW0003	Providing & fixing in position dressed wood work frames and 35mm thick pnalled or glazed shhutter complete including fittings and hinges as per drawing window type W4	1	each		
30	WW0003	Providing & fixing in position dressed wood work frames and 38 mm thick panalled or glazed shhutter complete including fittings and hinges as per drawing and directive of site engineer door type D1	3	each		

31	WW0003	Providing & fixing in position dressed wood work frames and 38 mm thick pnalled or glazed shhutter complete including fittings and hinges as per drawing and directive of site engineer door type D2	1	each		
32	WW0506	P&f. 100x12mm, with 25mm dia. wooden curtain rod and brackets incl. M.S.flats 25x3x100mm and plugs etc. complete: Mixed Conifer	36.16	m		
		PLUMBING AND SAINTATION				
33	PI0001	Providing & fixing G.I. pipes incl G.I. fittings & clamps & repair walls: 15mm	80	m		
34	PI0205	Providing & fixing c.p. brass bibcock: 15mm, standard vertical, c.p knob	3	each		
35	PI0126	Providing & fixing Kitchen Sinks including all connections and fittings : Stainless steel, 1740 x 520 x 200 mm, single bowl & double drain-board	1	each		
36	PO0565	Providing & fixing P.V.C Nahani Trap- 110mm inlet & 75mm each	1	each		
37	PO0370	Providing & fixing P.V.C soil wastes and vent pipes, single or double socketed incl, pipe clip complete (excl. the cost of P.V.C fittings): 75mm dia	15	m		
38	PO0415	Providing & fixing P.V.C door bend: 75mm dia	1	each		
39	PO0405	Providing & fixing P.V.C plain bend: 75mm dia	1	each		
40	SW0022	Steel work welded, in built up sections, trusses, frame-works incl. cutting, hoisting, fixing and appl. priming coat of red lead paint: In Tabular sections	2796.75	kg		

41	SW0021	Steel work welded, in built up sections, trusses, frame-works incl. cutting, hoisting, fixing and appl. priming coat of red lead paint: In Tees, angles, flats and channels	94.67	kg		
42	SW0080	Providing & fixing M.S. round hold-down bolts with nuts and washer plates	55.3	kg		
43	RF0003	Providing & fixing Pre Painted Steel Corrugated Roofing sheets, including bolts, hooks and nuts 8mm dia. with bitumen and G.I limpet washers filled with white lead for connection, excluding the cost of purlins, rafter and trusses.- 25g (0.50mm)	355.2	s q.m		
44	RF0007	Providing & fixing 600mm ridges or hips in Pre Painted Steel sheets, including bolts, hooks and nuts 8mm dia G.I limpet and bitumen washers for connection. 25g. (0.50mm) m	49.1	m		
45	RF0010	Providing & fixing 450mm over all semi-circular plain G.I gutter, including brackets, bolts, nuts, washers & rain water pipes connections, excluding the cost of pipes 24g sheet	75	m		
46	RF0192	Providing & fixing on wall face single socketed rigid PVC(working pressure 4kgf per sq-cm) Rain water pipes including jointing with seal ring leaving 10 mm gap for thermal expansion complete: 110mm dia.	11	m		
47	WW0030	Providing & fixing Eaves board(225x25mm) with moulding fitted & fixed with necessary screws: Mixed Conifer	75.6	m		
48	PL0042	Providing & laying 20mm cement plaster : C.M 1:5	1143.65	Sq.m		

49	DR 0002	Providing and laying 50mm thick plinth protection and grouted with fine sand mix incl. Well rammed, finishing the top smooth: With cement concrete 1:3:6, 20mm gravel or shingles laid over 75mm thick layer of compacted gravel (40mm)	67.2	Sq.m		
50	DR 0031	Constructing random rubble masonry open surface drain in cement mortar 1:6, including earth work in excavation, 100mm thick conc. base 1:5:10, 40mm aggregate 25mm thick cement concrete 1:2:4, 12mm aggregate for filling haunches, including 20mm cement plaster with a floating coat of neat cement, disposal of surplus earth. 150 X 200mm depth	54.3	m		
51	PT0040	Providing and applying finishing coats: Dry distemper, two coats on new work, incl. white priming coat	884	Sq.m		
52	PT0012	Providing & applying one coat of primers: Wood work - pink primer	655.01	Sq.m		
53	PT0047	Providing & applying finishing coats: Synthetic enamel, for steel & wood work / two coat on new work	655.01	Sq.m		
54	PT0101	Providing , preparing & applying Bhutanese paint Dangtshon Painting (Washable): Ding	1	lumsum		
55	SW0022	Providing and fixing steel railing made of Hollow tubes, channels, plates etc... including welding, grinding, buffing, polishing applying priming coat and making curvature as per drawing:vertical hollow tube 60*60*3 ,horizontal 60*30*3 and tsegay with ms plate3mm	14	m		

Name of Work: Construction of Farmers outlet at Gedu

Subhead:Bill of Quantity

Sl. No	BSR	Description of the Items	Qty.	Unit	Rate in fig	Rate in words	Amount
1	WC0301	Wiring for light, fans, call bell and 2 pin light socket outlet with 1.5 sq.mm 1.1kV grade, PVC insulated copper conductor cable in recessed HDPE pipe including connections, painting, testing and commissioning etc. as required (Medium Point)	23	Point			
2	WC0302	Wiring for light, fans, call bell and 2 pin light socket outlet with 1.5 sq.mm 1.1kV grade, PVC insulated copper conductor cable in recessed HDPE pipe including connections, painting, testing and commissioning etc. as required (long point)	3	Point			
3	WC0391	Wiring for lighting circuit with 1.1kV grade, PVC insulated copper conductor cable in recessed HDPE pipe including connections, painting, testing and commissioning etc. as required (2x2.5 sq.mm)	206	m			
4	WC0341	Wiring for 5/6 pin, 6/16A plug point with 4sq.mm 1.1kV grade, PVC insulated copper conductor cable in recessed HDPE pipe with providing and fixing 5/6 pin, 6/16A socket outlet and switch including earthing the third pin, connections, painting, testing and commissioning etc. as required (Midium Point)	10	Point			
5	WC0342	Wiring for 5/6 pin, 6/16A plug point with 4sq.mm 1.1kV grade, PVC insulated copper conductor cable in recessed HDPE pipe with providing and fixing 5/6 pin, 6/16A socket outlet and switch including earthing the third pin, connections, painting, testing and commissioning etc. as required (Long Point)	8	Point			
6	LS0131	Supplying and installation of LED tube fittings complete with all accessories complete as required. (18watt LED)	13	each			

7	IL0065	Supplying of prewired indoor rails and wall brackets on surface / ceiling mounted luminaries suitable for GLS,CFL & LED lamps for maximum wattage upto 1x60 watts complete with all accessories such as base, holder, reflector, rails, glass globe, etc etc. but without lamp (Wall bracket upward projection 230mm, height 225mm finish-painted globe 360/400mm dia.. glass milky/ frosted, 1x60W)		6 each			
8		Supplying of LED lamp 250V A.C (LED lamp 12W(BC))		10 each			
9		Supplying & fixing of metal boxes for switch/socket outlet/switch socket combined/ gang switches on surface including painting etc as required (3module)		18 each			
10		Supplying & fixing of metal boxes for switch/socket outlet/switch socket combined/ gang switches on surface including painting etc as required(6module)		2 each			
11		Supplying & fixing of metal boxes for switch/socket outlet/switch socket combined/ gang switches on surface including painting etc as required(4 module)		3			
12		Supplying & fixing of metal boxes for switch/socket outlet/switch socket combined/ gang switches on surface including painting etc as required(2 module)		2			
13		Supplying & fixing of metal boxes for switch/socket outlet/switch socket combined/ gang switches on surface including painting etc as required(1 module)		2 each			
14	GB0270+EI0380	Supplying, installation, testing and commissioning of miniature circuit breaker (MCB) single pole, 230V A.C complete with all accessories suitable to fix on a din- bar etc. as required to accommodate on/in prefabricated MS surface/ MS cubical control panel board including drilling holes, connections etc. as required (6A)		4 each			

15	GB0272+EI0380	Supplying, installation, testing and commissioning of miniature circuit breaker (MCB) single pole, 230V A.C complete with all accessories suitable to fix on a din- bar etc. as required to accommodate on/in prefabricated MS surface/ MS cubical control panel board including drilling holes, connections etc. as required (16A)	18	each			
16	GB0165+EI0411	Supplying of panel moulded case circuit breaker (MCCB) with electronic release, breaking capacity 16KA, 3 pole 415 volt A.C complete with all accessories etc. as required (125A)	1	each			
17	GB0562+EI0535	Supply, installation testing and commissioning of TPN distribution board (DIN type, vertical) with arcylic door, 415 volt A.C complete with all accessories without MCB/isolator/RCCB out going or incoming etc. as required (6Way)	1	each			
18	WC0414	Wiring for sub-main with 1.1kV grade, PVC insulated copper conductor cable in recessed HDPE pipe including connections, painting, testing and commissioning etc. as required (4X10SQMM)	15	m			
19	PC0150+CL0003	Supply and Laying of one number 25Sqmm 3.5core PVC insulated and sheathed power cable copper/aluminium,armoured/un-armoured 1.1KV single core to four core direct in the ground including excavation, sand cushioning, protective covering and refilling the trenches etc. as required	150	m			
20	ET0001	Providing and fixing of earthing including all accessories, machinery enclosure, C.I cover plate having locking arrangement, watering pipe with excavation and refilling work including charcoal or coke and salt complete as required as per standard earthing drawing (With G.I earth plate 600x600x6mm)	2	each			

21	ET0015	Providing and laying earth connection from earth electrodes in 15mm dia G.I pipe from earth electrodes as required as per guidance of standard earthing drawing (With 4.06mm dia (8SWG) G.I wire)	12	m			
22	AR	Providing and erection of wooden box with wire mesh to hold main switches including painting etc. as required as per site engineer's instruction (600x450x230mm deep)	1	each			
23		Providing and erection of Watt Hour Meter, 415V A.C complete with all accessories including meter security, energy security and meter connection etc. as required from the concerned BPCL (15-20A,3-phase Watt Hour Meter)	1	each			

REVISED ARCHITECTURAL DRAWINGS FOR THE PROPOSED FARMSHOP AT GEDU



ཕྱི་དབང་ལྷན་ཁག་གི་ལྷན་ཚོགས་ཀྱི་འཕུལ་སྐྱོད་ལྷན་ཁག་
ROYAL GOVERNMENT OF BHUTAN
DZONGKHAG ADMINISTRATION
Ngoedrup-Tse Dzong: Chhukha
 ལྷན་ཚོགས་ཀྱི་འཕུལ་སྐྱོད་ལྷན་ཁག་



PROPOSED MODEL FARM SHOP		DRAWN BY	APPROVED BY	DATE	ISSUED FOR	DRAWING NO.
DRAWING TITLE	DRAWING	ARCHITECT	M.E / D.E	13.08.2019	APPROVAL	
ARCHITECTURAL DRAWINGS				SCALE	REVISION NO:	0
CHHUKHA DZONGKHAG ADMINISTRATION				NTS	00	

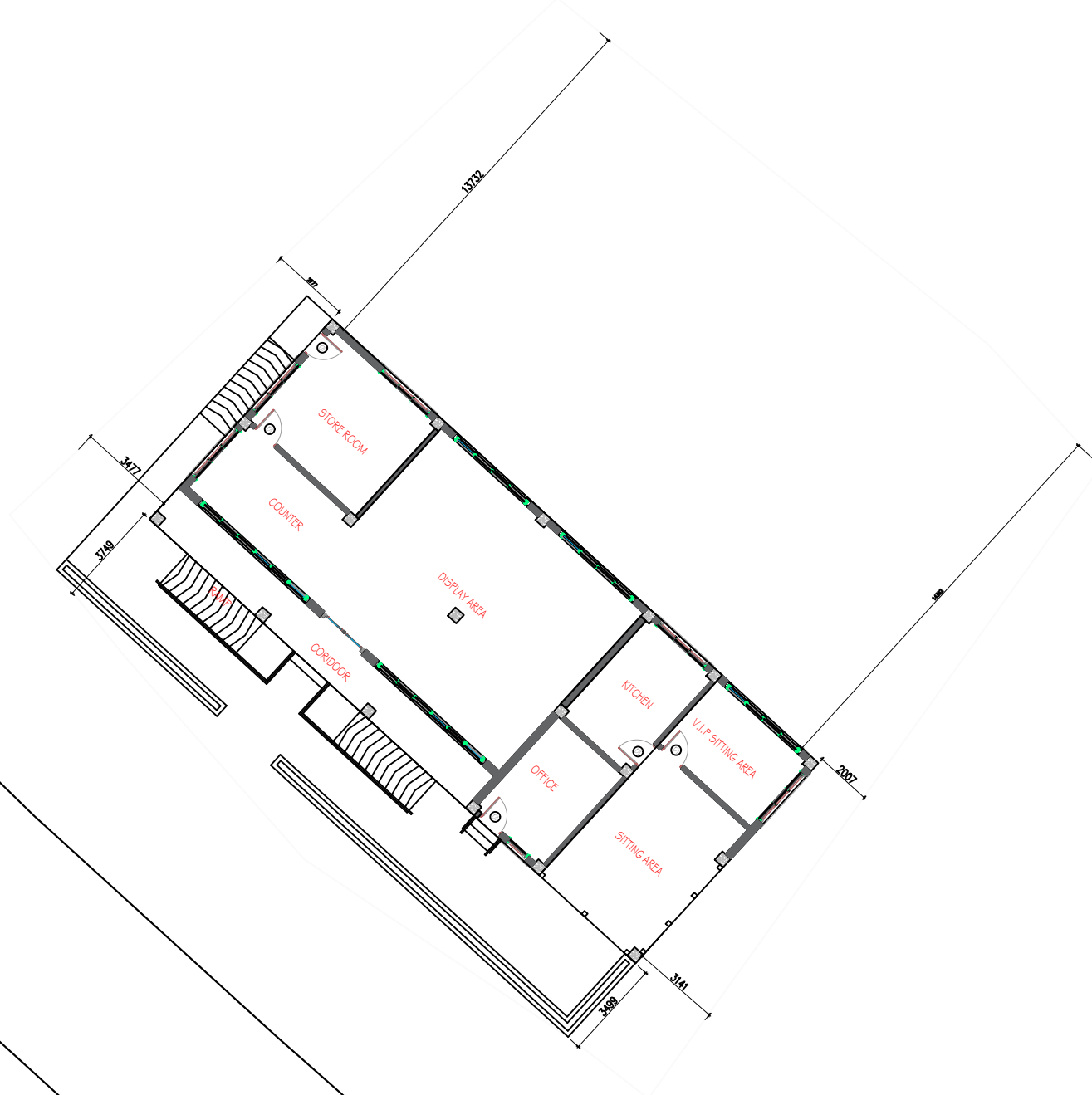

PROPOSED MODEL FARM SHOP

DRAWING TITLE	DRAWING
ARCHITECTURAL DRAWINGS	SITE PLAN
CHHUKHA DZONGKHAG ADMINISTRATION	

DRAWN BY	APPROVED BY	DATE	ISSUED FOR	DRAWING NO.
ARCHITECT	M.E / D.E	13.08.2019	APPROVAL	
		SCALE	REVISION NO:	
		NT5	00	1



ལྷ་དབང་ལྷན་འབྲེལ་གཞུང་།
 རྒྱལ་ལོ་བཀའ་བདག་རྒྱུང་། དངོས་གྲུབ་ཚེ་རིང་། ལྷ་ལ།
ROYAL GOVERNMENT OF BHUTAN
DZONGKHAG ADMINISTRATION
Ngoedrup-Tse Dzong: Chhukha
 ལོ་རྒྱུག་གི་ལྷན་འབྲེལ་པུན་ལྷན་ཁང་།



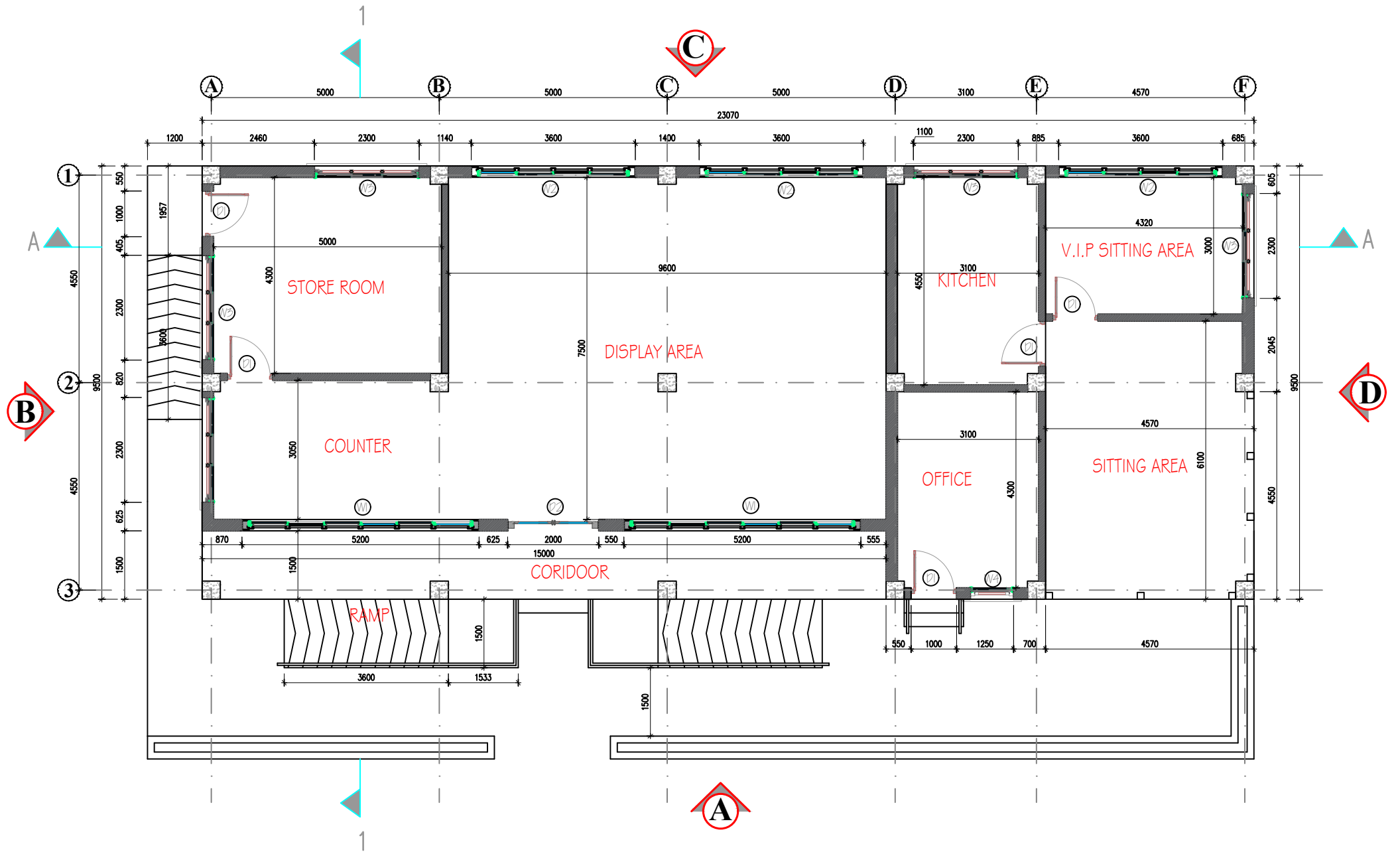

ལྷན་ཁབ་རྒྱལ་ཁབ་རྒྱུ་རྒྱུ་
 རྒྱལ་ཁབ་རྒྱུ་རྒྱུ་ རྒྱུ་རྒྱུ་རྒྱུ་
ROYAL GOVERNMENT OF BHUTAN
DZONGKHAG ADMINISTRATION
Ngoedrup-Tse Dzong: Chhukha
 ལྷན་ཁབ་རྒྱུ་རྒྱུ་



PROPOSED MODEL FARM SHOP	
DRAWING TITLE	DRAWING
ARCHITECTURAL DRAWINGS	PLAN
CHHUKHA DZONGKHAG ADMINISTRATION	

DRAWN BY	APPROVED BY	DATE	ISSUED FOR	DRAWING NO.
ARCHITECT	M.E / D.E	13.08.2019	APPROVAL	2
		SCALE	REVISION NO:	
		NTS	01	

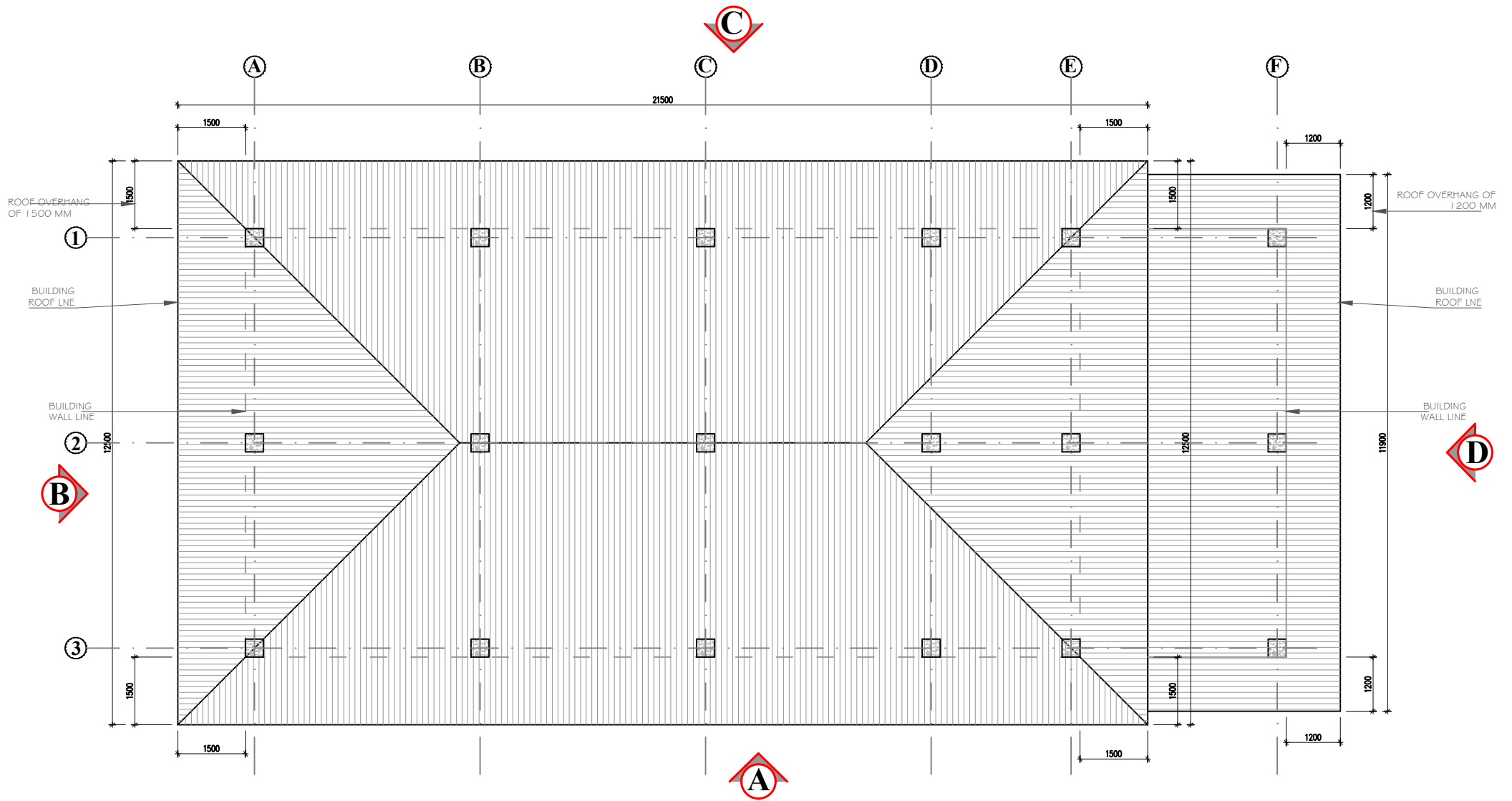

ཡུལ་སྐོར་འབྲུག་གཞི་རྒྱུ་
 རྒྱལ་ཁབ་བདག་ཀླུང་། དངོས་གྲུབ་ཚུ་རྫོང་། ལྷ་ཁག
ROYAL GOVERNMENT OF BHUTAN
DZONGKHAG ADMINISTRATION
Ngoedrup-Tse Dzong: Chhukha
 ལོ་འོ་ལོ་ལོ་ལོ་



DRAWING TITLE		DRAWN BY	APPROVED BY	DATE	ISSUED FOR	DRAWING NO.
PROPOSED MODEL FARM SHOP		ARCHITECT	M.E / D.E	13.08.2019	APPROVAL	3
ARCHITECTURAL DRAWINGS				SCALE	REVISION NO:	
CHHUKHA DZONGKHAG ADMINISTRATION				NTS	01	

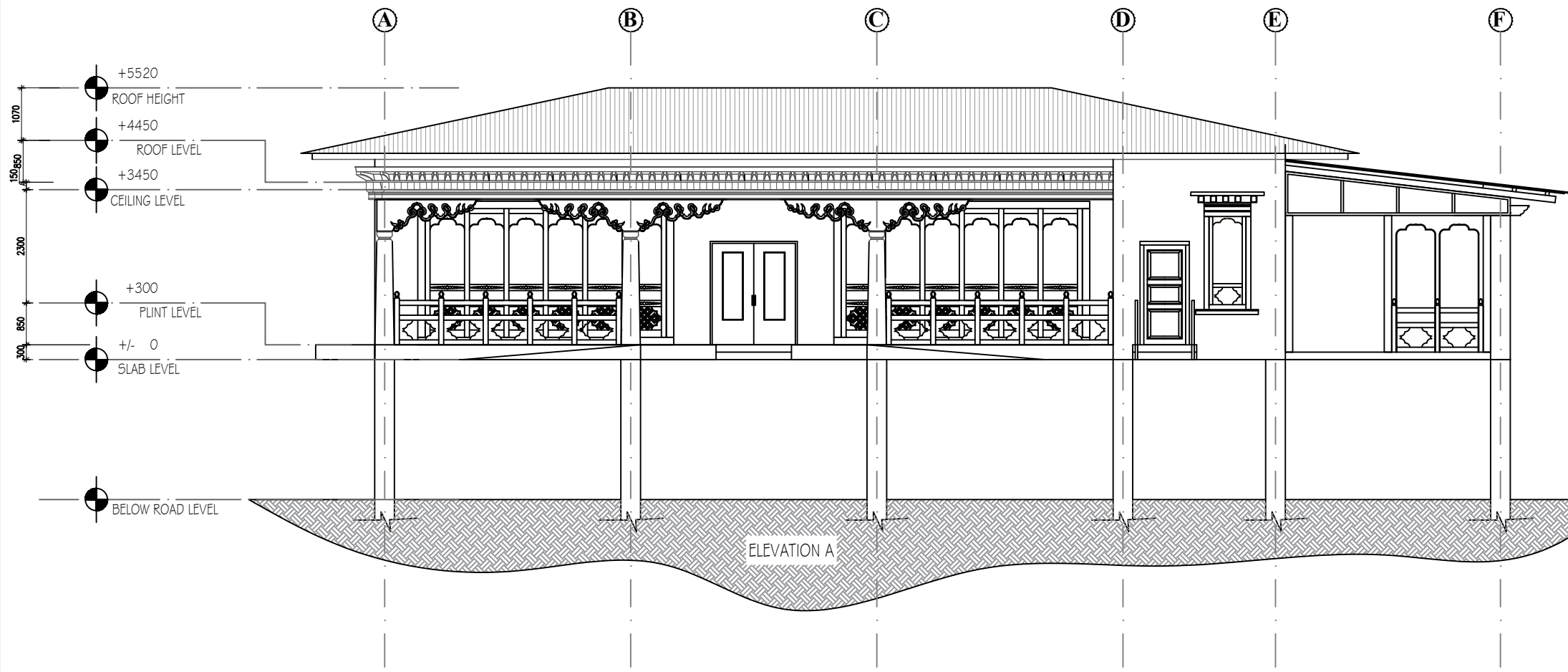

ELEVATION A



ལྷ་དབུ་མཚན་འབྲུག་གཞུང་།
 རྒྱལ་ཁབ་བདག་ཀྱིས་། དངོས་གྲུབ་ཚེ་རིང་། ལྷ་ལ།
ROYAL GOVERNMENT OF BHUTAN
DZONGKHAG ADMINISTRATION
Ngoedrup-Tse Dzong: Chhukha
 ལོ་རྒྱུག་གི་ལྷ་མོ་ལྷོ་མོ་།



PROPOSED MODEL FARM SHOP	
DRAWING TITLE	DRAWING
ARCHITECTURAL DRAWINGS	ELEVATION
CHHUKHA DZONGKHAG ADMINISTRATION	

DRAWN BY	APPROVED BY	DATE	ISSUED FOR	DRAWING NO.
ARCHITECT	M.E / D.E	13.08.2019	APPROVAL	4
		SCALE	REVISION NO:	
		NTS	01	

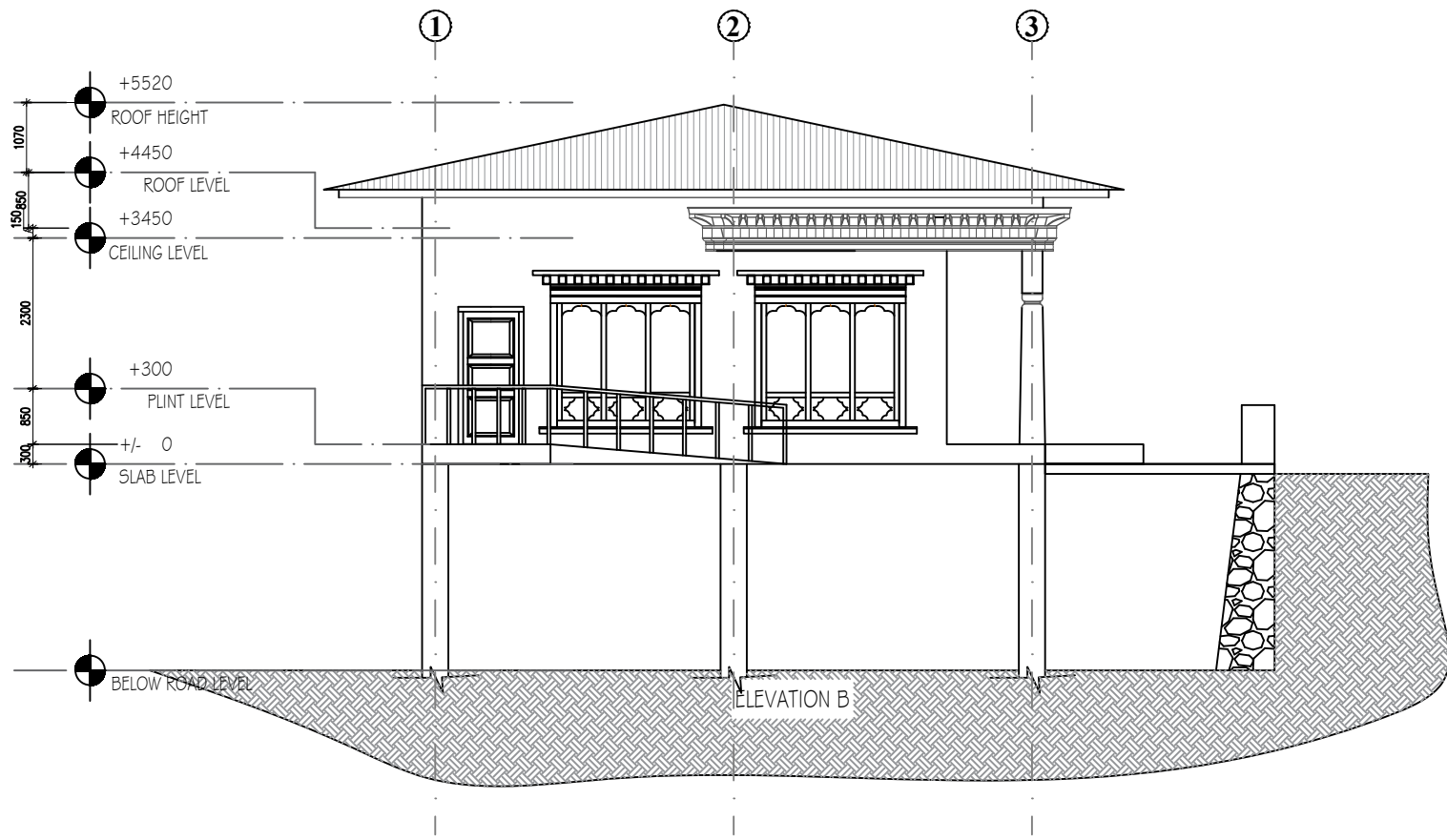

PROPOSED MODEL FARM SHOP	
DRAWING TITLE	DRAWING
ARCHITECTURAL DRAWINGS	SECTIONS
CHHUKHA DZONGKHAG ADMINISTRATION	

DRAWN BY	APPROVED BY	DATE	ISSUED FOR	DRAWING NO.
ARCHITECT	M.E / D.E	13.08.2019	APPROVAL	
		SCALE	REVISION NO:	
		NTS	01	5

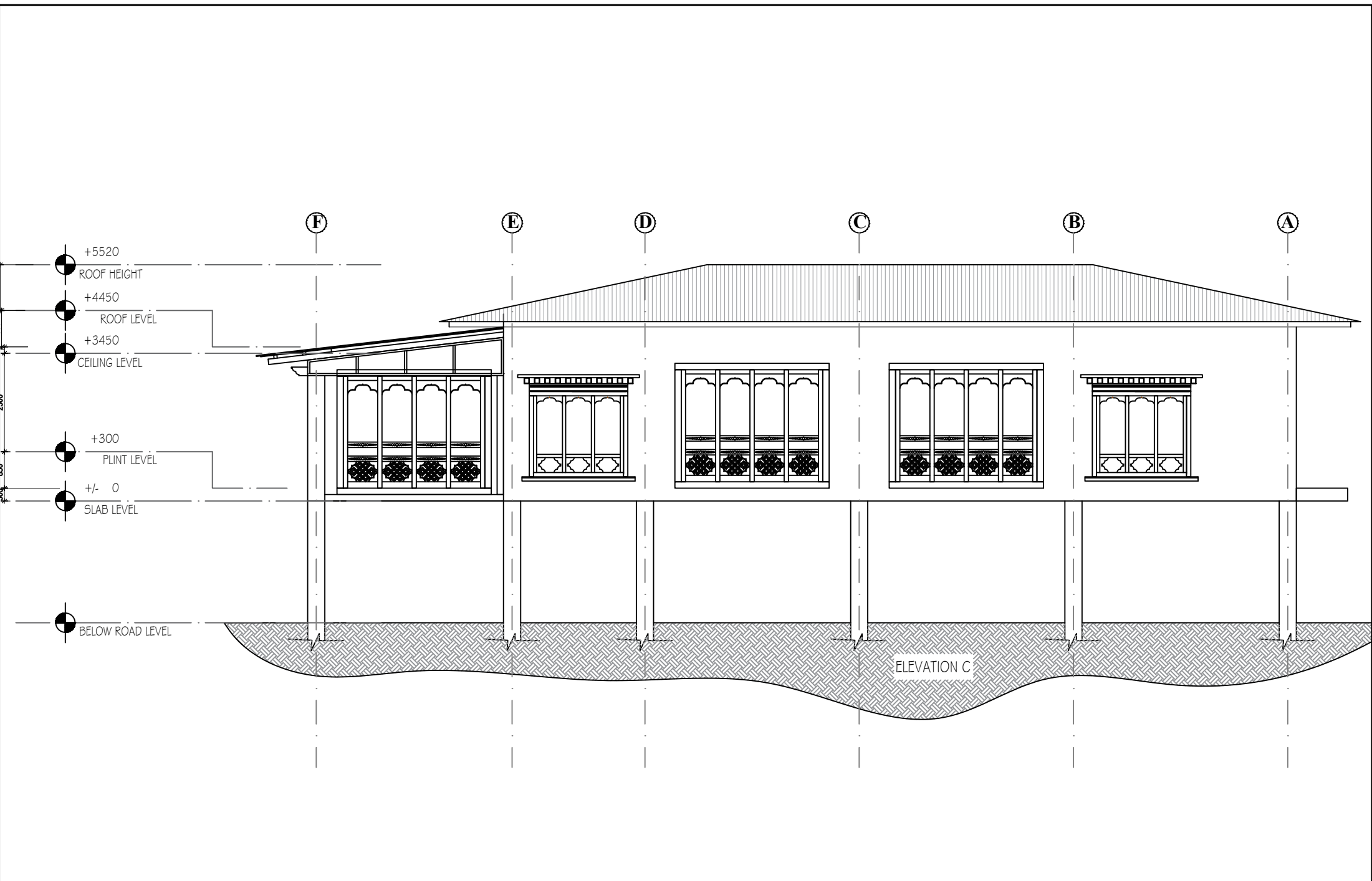

ལྷ་དཔལ་ལྷན་འབྲུག་གཞུང་།
 རྒྱལ་ཁབ་བདག་ཀྱིས་ དངོས་གྲུབ་ཚུ་རྒྱུ་ ལྷ་ལ།
ROYAL GOVERNMENT OF BHUTAN
DZONGKHAG ADMINISTRATION
Ngoedrup-Tse Dzong: Chhukha
 ལོ་ལོ་ལོ་ལོ་



PROPOSED MODEL FARM SHOP

DRAWING TITLE	DRAWING
ARCHITECTURAL DRAWINGS	ELEVATION
CHHUKHA DZONGKHAG ADMINISTRATION	

DRAWN BY	APPROVED BY	DATE	ISSUED FOR	DRAWING NO.
ARCHITECT	M.E / D.E	13.08.2019	APPROVAL	6
		SCALE	REVISION NO:	
		NTS	01	

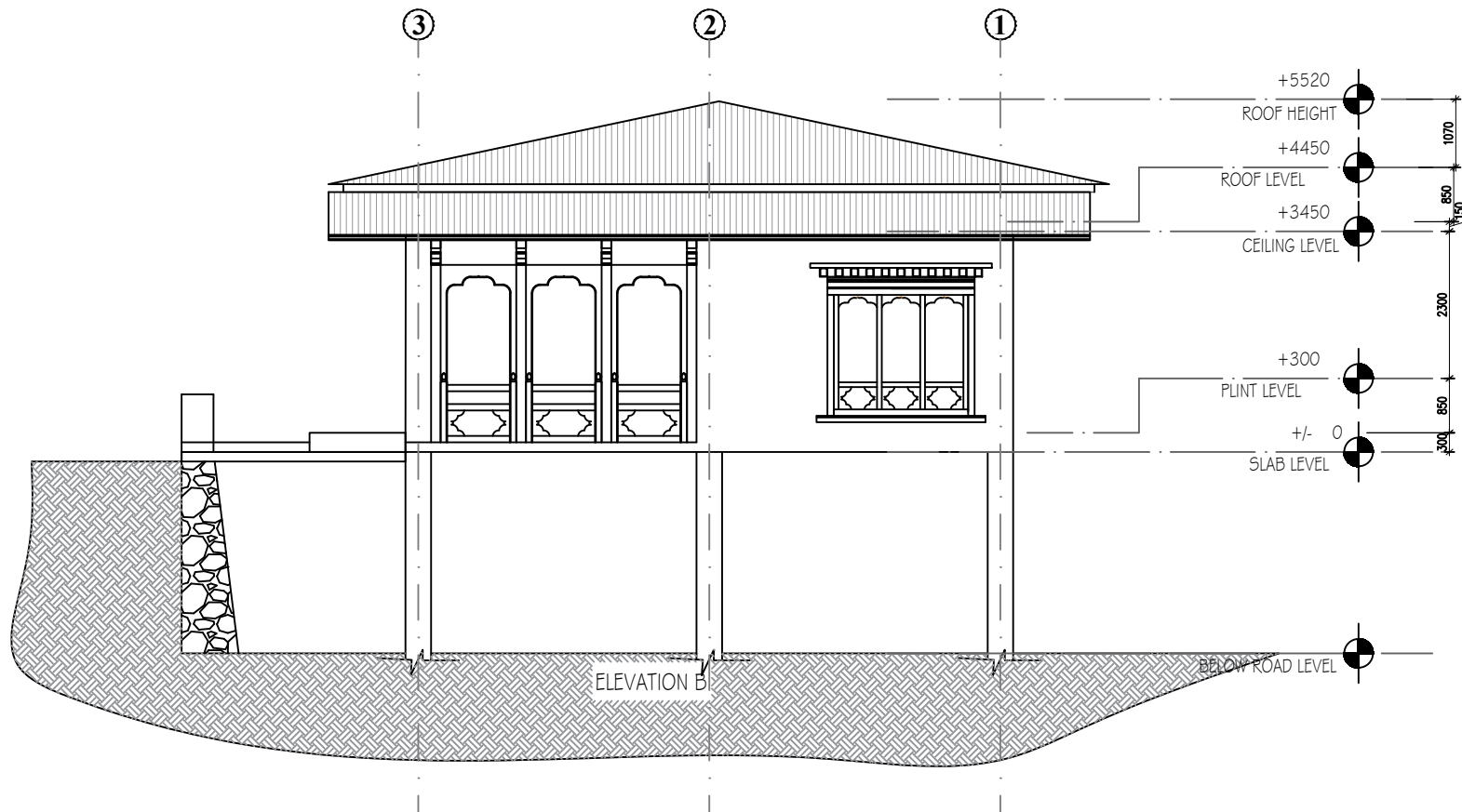

ལྷ་དཔལ་ལྷན་འབྲུག་གཞུང་།
 རྒྱལ་ལོན་པ་བདག་ཀྱིས་། དངོས་གྲུབ་ཅེ་རྒྱུ་ལ། ལྷ་ལ།
ROYAL GOVERNMENT OF BHUTAN
DZONGKHAG ADMINISTRATION
Ngoedrup-Tse Dzong: Chhukha
 ལོན་ལོན་ལྷན་འབྲུག་པ་ལྷན་འབྲུག་གཞུང་།



DRAWING TITLE		DRAWING	
ARCHITECTURAL DRAWINGS		ELEVATION	
CHHUKHA DZONGKHAG ADMINISTRATION			

DRAWN BY	APPROVED BY	DATE	ISSUED FOR	DRAWING NO.
ARCHITECT	M.E / D.E	13.08.2019	APPROVAL	
		SCALE	REVISION NO:	
		NTS	01	7

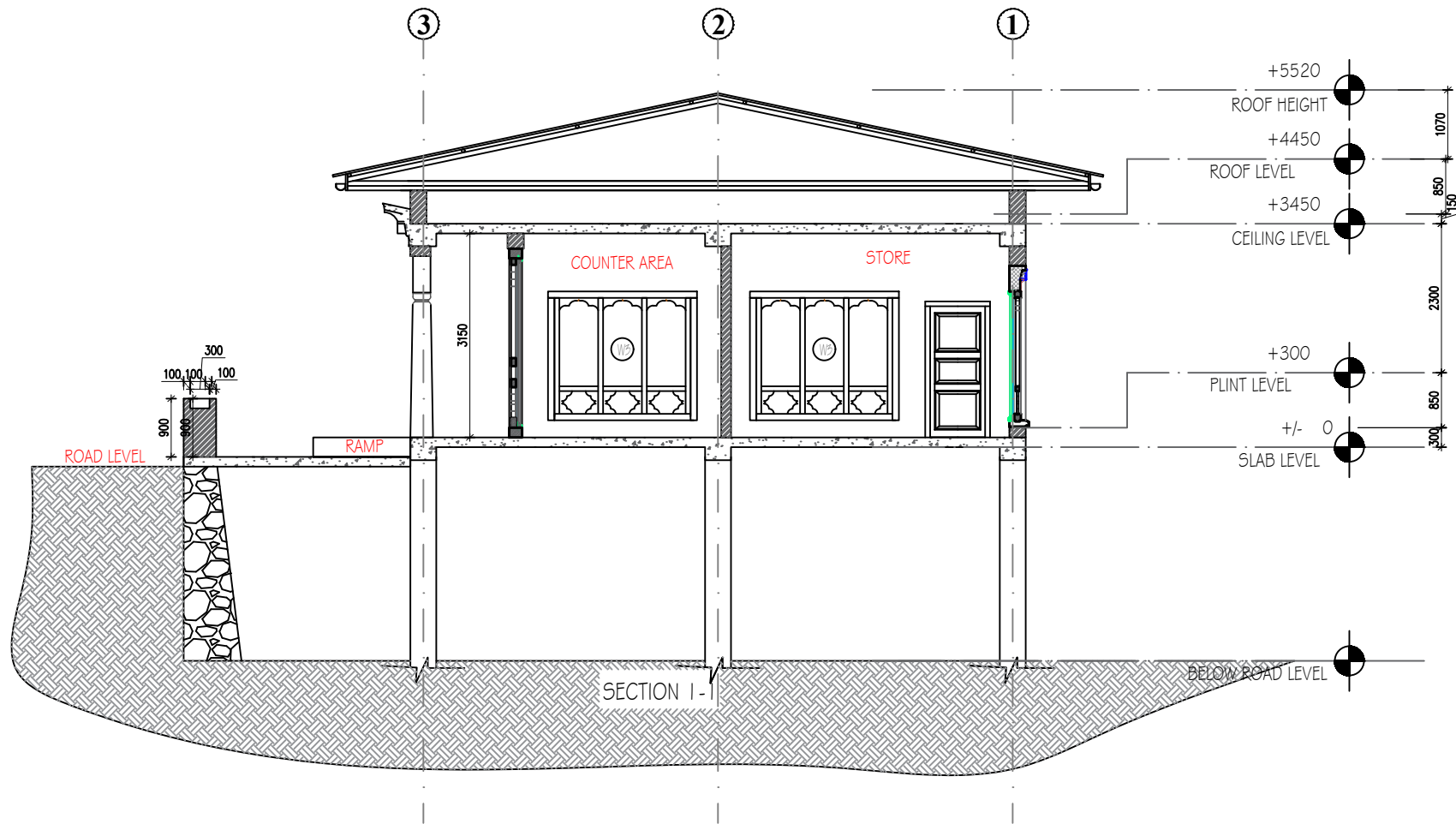

PROPOSED MODEL FARM SHOP

ལྷ་དབལ་ལྷན་འབྲུག་གཞུང་།
 རྒྱལ་ཁབ་བདག་ཀྱིས་། དངོས་གྲུབ་ཚུ་རྒྱུད་། ལྷ་ལ།
ROYAL GOVERNMENT OF BHUTAN
DZONGKHAG ADMINISTRATION
Ngoedrup-Tse Dzong: Chhukha
 ལོ་འོ་ལོ་ལོ་ལོ་



DRAWING TITLE		DRAWING	
ARCHITECTURAL DRAWINGS		SECTIONS	
CHHUKHA DZONGKHAG ADMINISTRATION			

DRAWN BY	APPROVED BY	DATE	ISSUED FOR	DRAWING NO.
ARCHITECT	M.E / D.E	13.08.2019	APPROVAL	
		SCALE	REVISION NO:	
		NTS	01	8

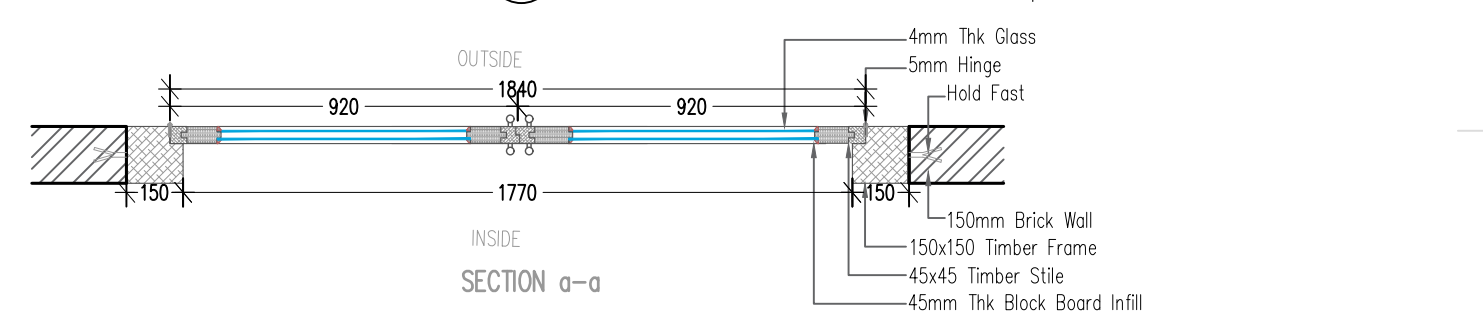
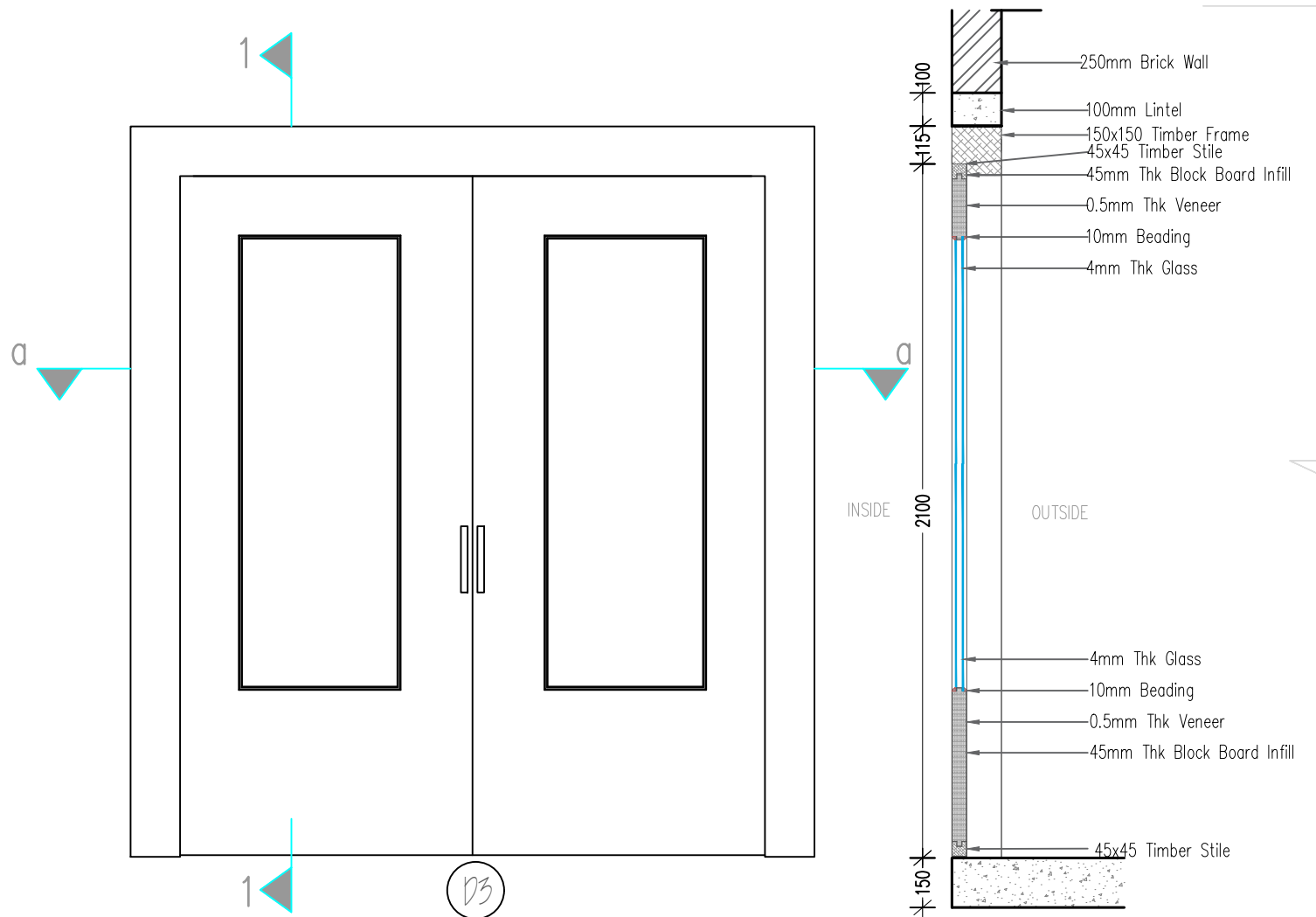

SECTION a-a

PROPOSED MODEL FARM SHOP

DRAWING TITLE	DRAWING
ARCHITECTURAL DRAWINGS	DOOR DETAILS
CHHUKHA DZONGKHAG ADMINISTRATION	

DRAWN BY	APPROVED BY	DATE	ISSUED FOR	DRAWING NO.
ARCHITECT	M.E / D.E	13.08.2019	APPROVAL	
SCALE			REVISION NO:	
NTS			01	9



ལྷ་དབང་ལྷན་འབྲུག་གཞུང་།
 རྒྱལ་ཁབ་བདག་སྐྱོང་། དངོས་གྲུབ་ཙུང་ཚོང་། ལྷ་ལ།
ROYAL GOVERNMENT OF BHUTAN
DZONGKHAG ADMINISTRATION
Ngoedrup-Tse Dzong: Chhukha
 ལོ་འཛིན་མི་རྒྱུ་



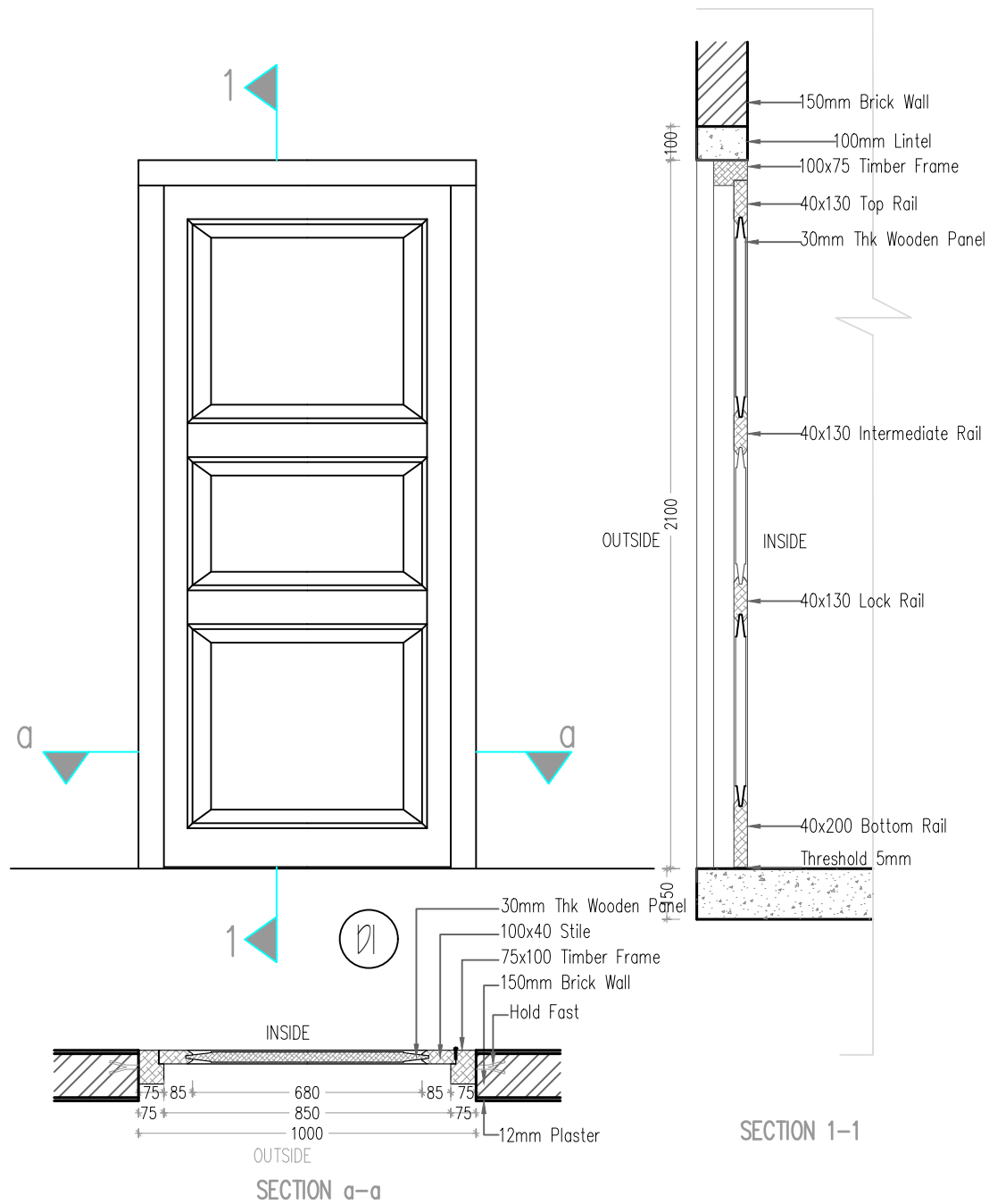

SECTION 1-1

SECTION a-a

PROPOSED MODEL FARM SHOP

DRAWING TITLE		DRAWING	
ARCHITECTURAL DRAWINGS		DOOR DETAILS	
CHHUKHA DZONGKHAG ADMINISTRATION			

DRAWN BY	APPROVED BY	DATE	ISSUED FOR	DRAWING NO.
ARCHITECT	M.E / D.E	13.08.2019	APPROVAL	
SCALE			REVISION NO:	
NTS			01	10



ལྷ་དཔལ་ལྷན་འབྲུག་གཞུང་།
 རྒྱལ་ཁབ་བདག་སྐྱོང་། དངོས་གྲུབ་ཚུ་རྫོང་། ལྷ་ལ།
ROYAL GOVERNMENT OF BHUTAN
DZONGKHAG ADMINISTRATION
Ngoedrup-Tse Dzong: Chhukha
 ལོ་འོ་ལོ་ལོ་ལོ་



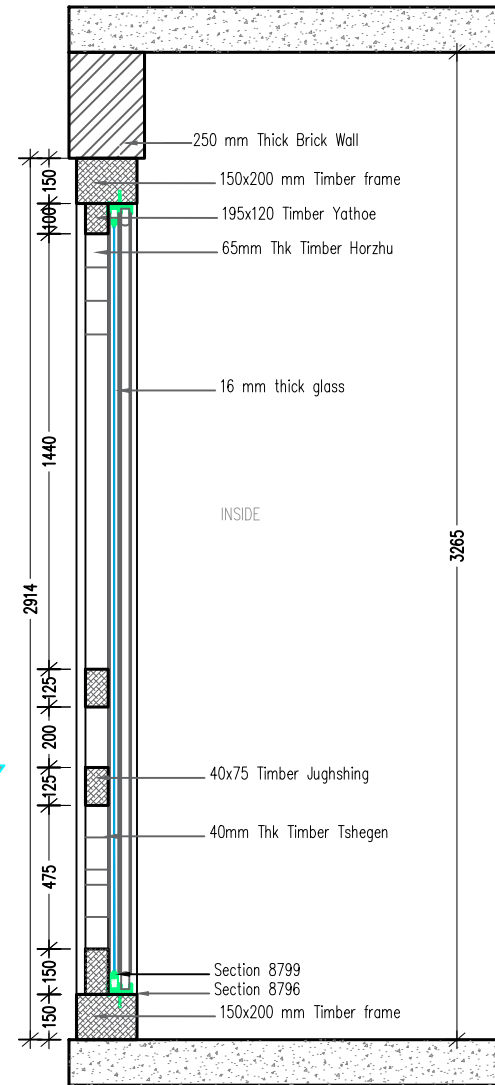
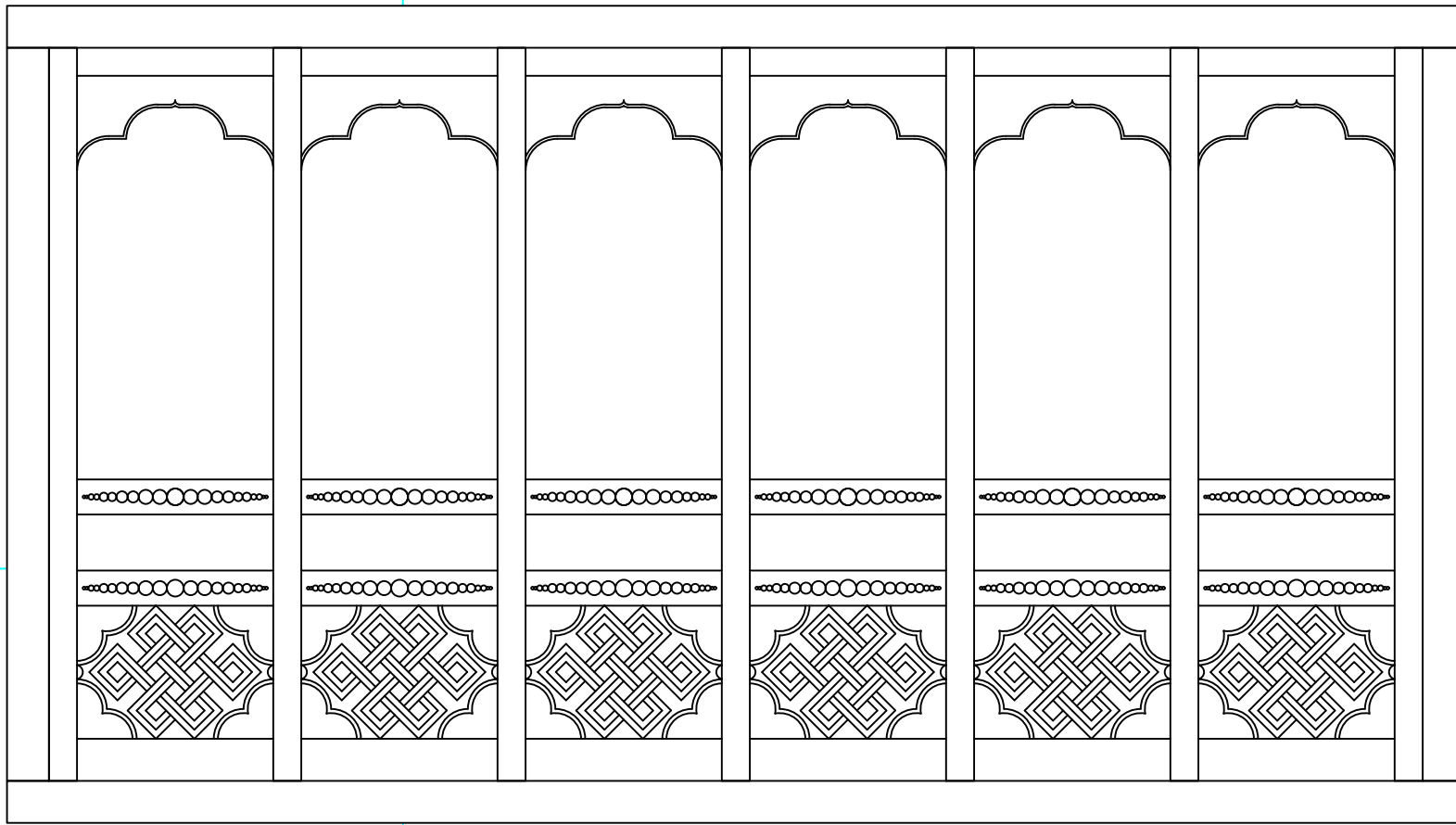

SECTION 1-1

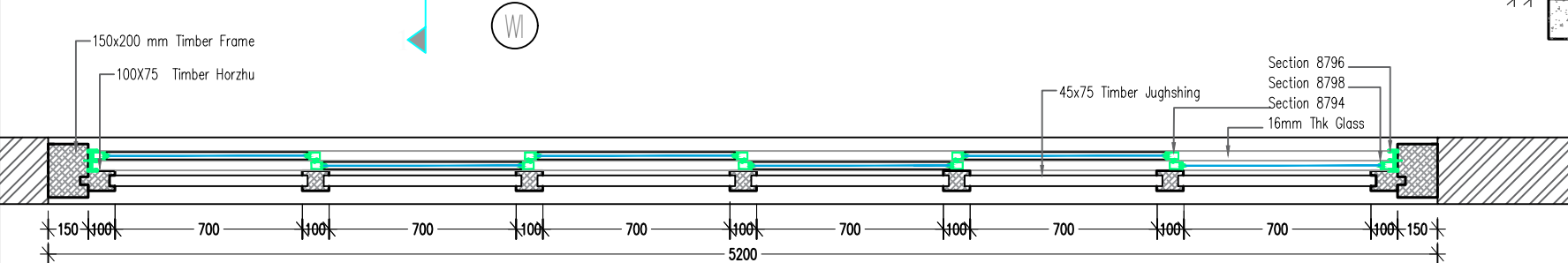

SECTION a-a

ལྷ་དབང་ལྷན་འབྲུག་གཞུང་།
 རྒྱལ་ཁབ་བདག་སྐྱོང་། དངོས་གྲུབ་ཚེ་རིང་། ལྷ་ལ།
ROYAL GOVERNMENT OF BHUTAN
DZONGKHAG ADMINISTRATION
Ngoedrup-Tse Dzong: Chhukha
 ལོ་ལོ་མཚོ་ལོ་ལོ་

PROPOSED MODEL FARM SHOP	
DRAWING TITLE	DRAWING
ARCHITECTURAL DRAWINGS	WINDOW DETAILS
CHHUKHA DZONGKHAG ADMINISTRATION	

DRAWN BY	APPROVED BY	DATE	ISSUED FOR	DRAWING NO.
ARCHITECT	M.E./D.E	13.08.2019	APPROVAL	
SCALE			REVISION NO:	
NT5			01	11

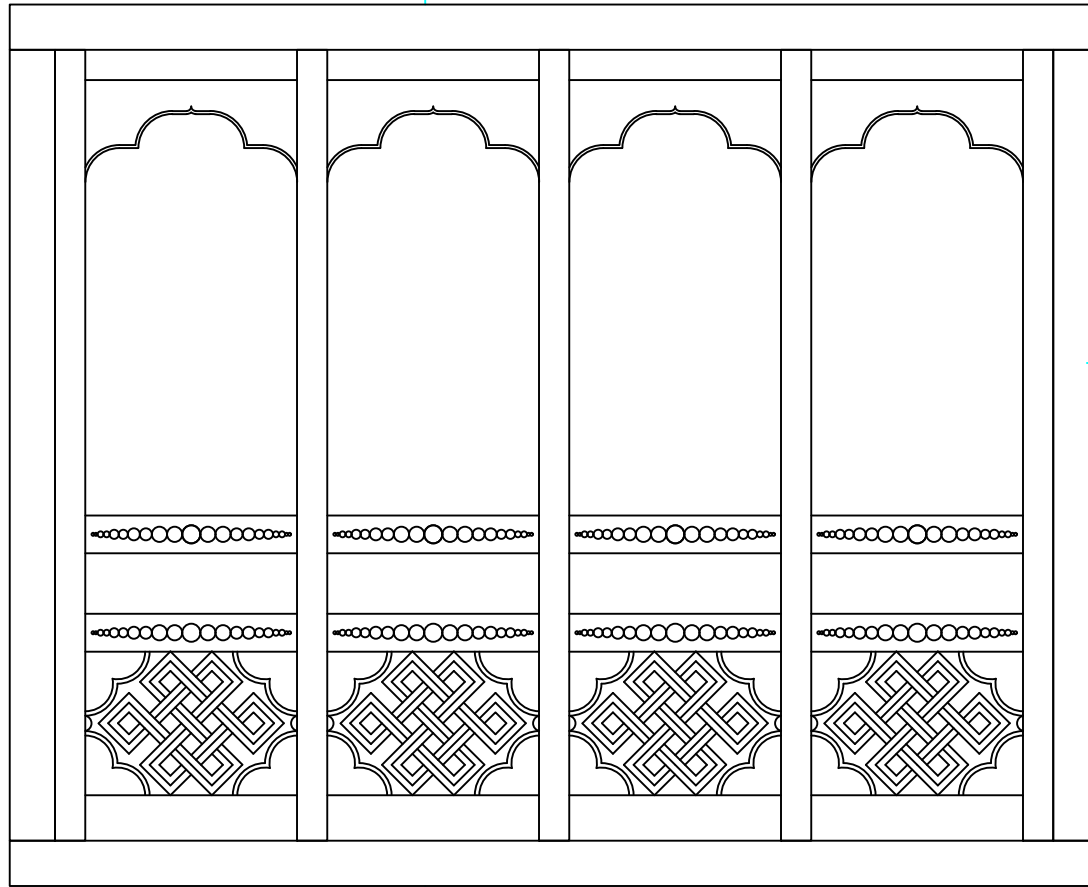

OUTSIDE

INSIDE

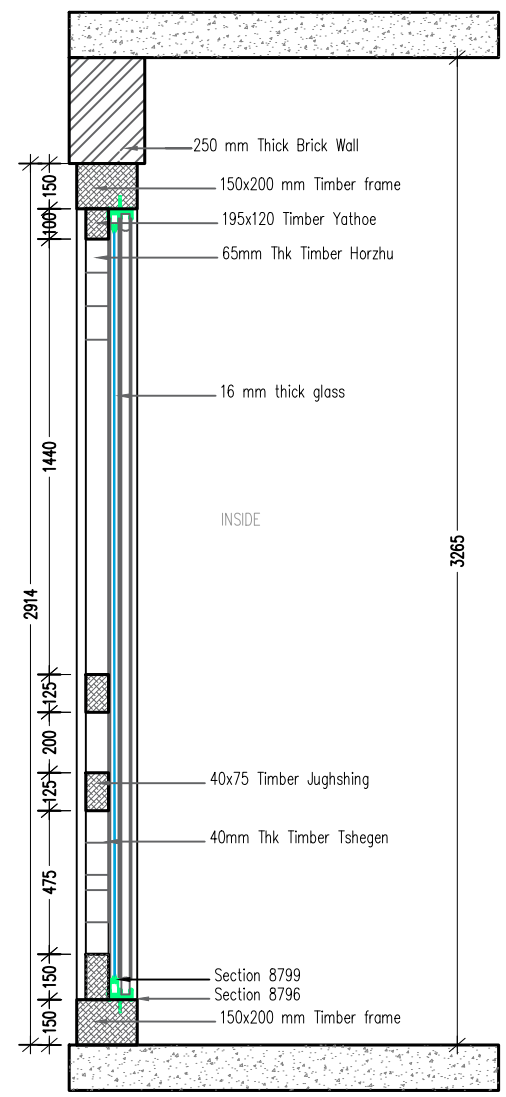

SECTION 1-1

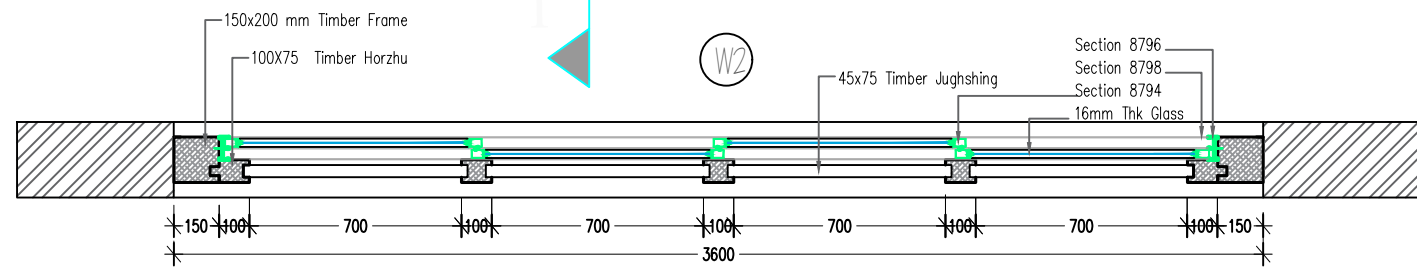

SECTION a-a



ལྷ་དཔལ་ལྷན་འབྲུག་གཞུང་།
 རྒྱལ་ཁབ་བདག་ཀྱིས་། དངོས་གྲུབ་ཅེ་རྒྱུད་། ལྷ་ལ།
ROYAL GOVERNMENT OF BHUTAN
DZONGKHAG ADMINISTRATION
Ngoedrup-Tse Dzong: Chhukha
 ལོ་འོ་ལོ་ལོ་ལོ་



PROPOSED MODEL FARM SHOP	
DRAWING TITLE	DRAWING
ARCHITECTURAL DRAWINGS	WINDOW DETAILS
CHHUKHA DZONGKHAG ADMINISTRATION	

DRAWN BY	APPROVED BY	DATE	ISSUED FOR	DRAWING NO.
ARCHITECT	M.E / D.E	13.08.2019	APPROVAL	
		SCALE	REVISION NO:	
		NT5	01	12

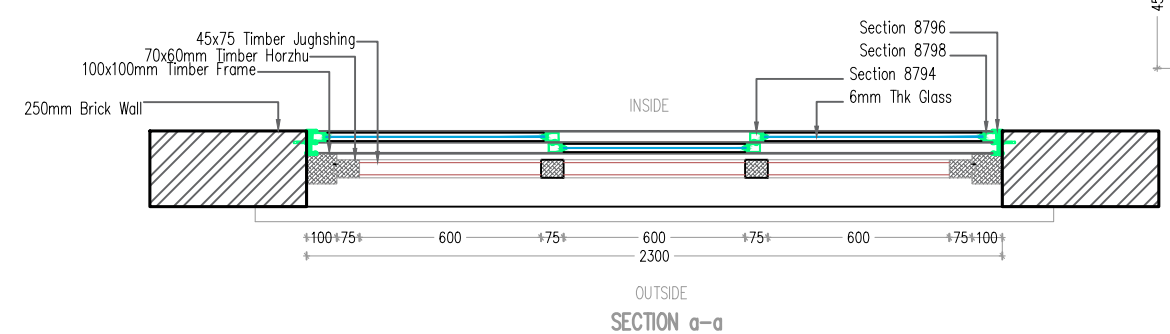
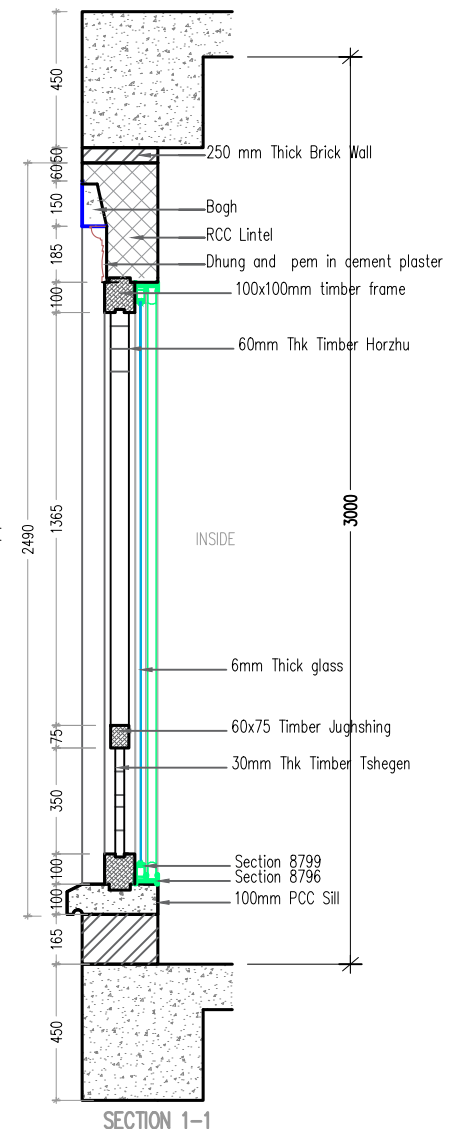
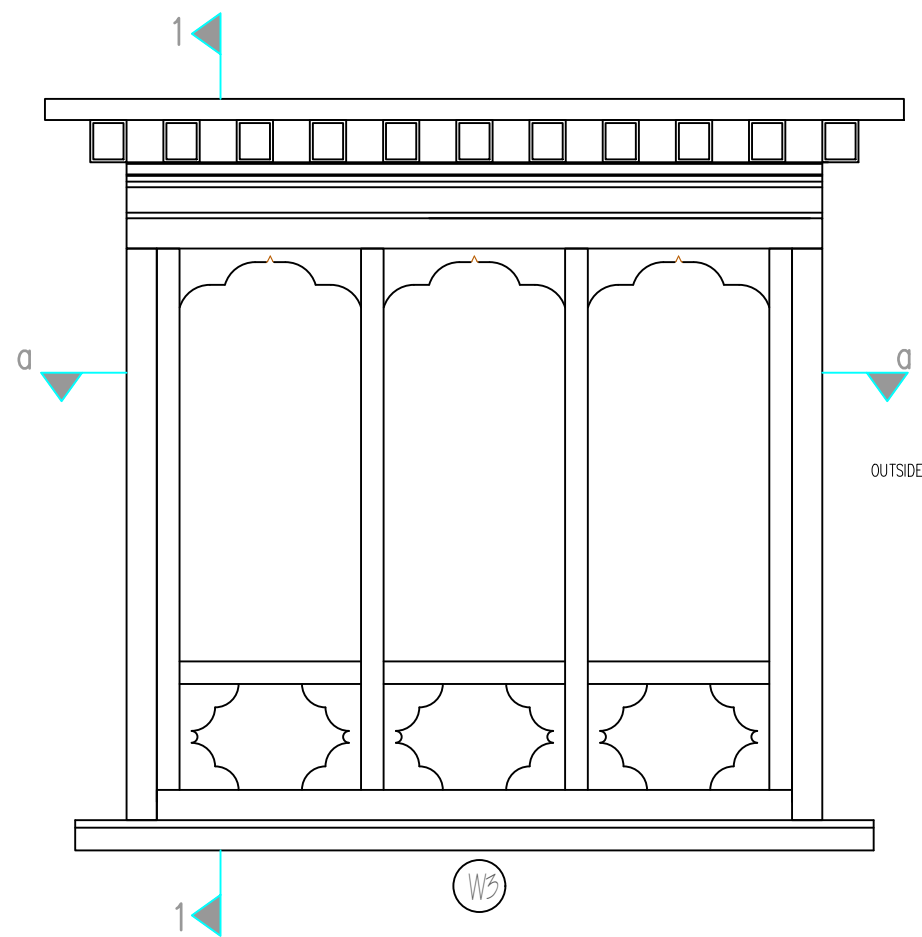

PROPOSED MODEL FARM SHOP

DRAWING TITLE		DRAWING	
ARCHITECTURAL DRAWINGS		WINDOW DETAILS	
CHHUKHA DZONGKHAG ADMINISTRATION			

DRAWN BY	APPROVED BY	DATE	ISSUED FOR	DRAWING NO.
ARCHITECT	M.E / D.E	13.08.2019	APPROVAL	
SCALE			REVISION NO:	
NTS			01	13



ལྷ་དབལ་ལྷན་འབྲུག་གཞུང་།
 རྒྱལ་ལོག་འབད་ལྷན་ཁྲིམས་འཛིན་ཚུ་གི་སྡེ་ཁག་།
ROYAL GOVERNMENT OF BHUTAN
DZONGKHAG ADMINISTRATION
Ngoedrup-Tse Dzong: Chhukha
 ལོག་འཛིན་ཚུ་གི་སྡེ་ཁག་།

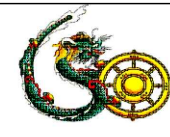

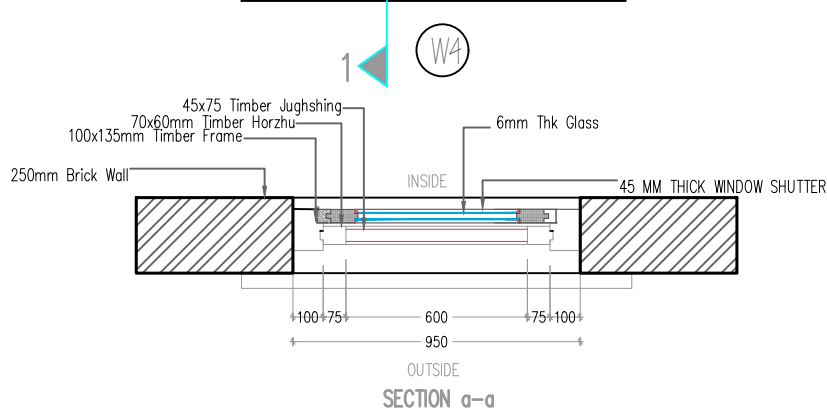
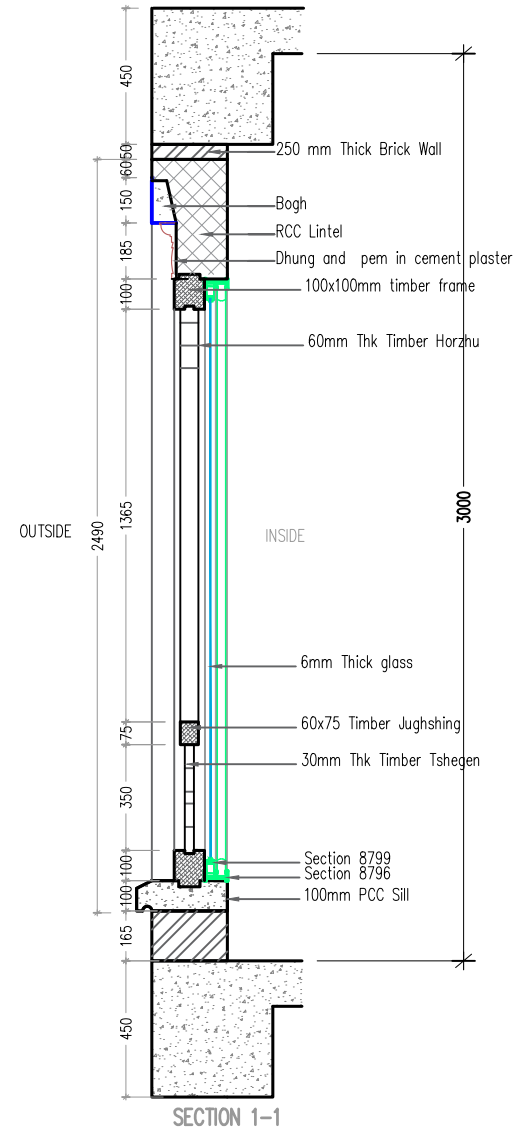
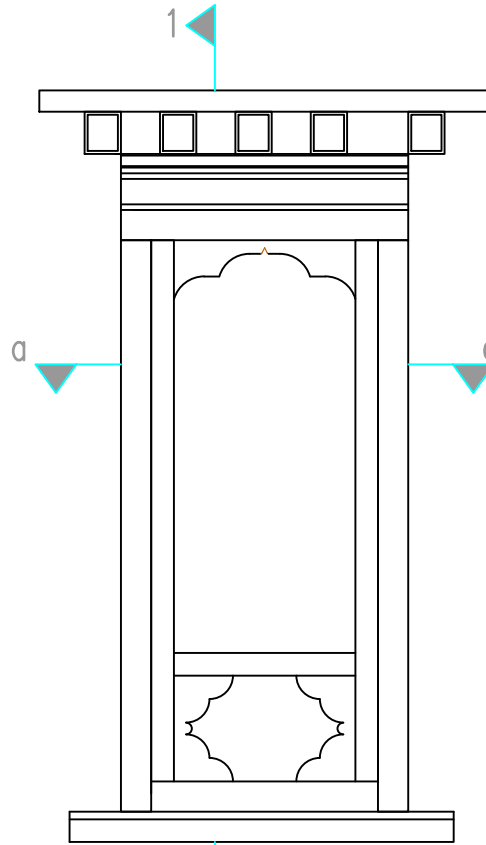

PROPOSED MODEL FARM SHOP

DRAWING TITLE

DRAWING

ARCHITECTURAL DRAWINGS

WINDOW DETAILS

CHHUKHA DZONGKHAG ADMINISTRATION

DRAWN BY	APPROVED BY	DATE	ISSUED FOR	DRAWING NO.
ARCHITECT	M.E / D.E	13.08.2019	APPROVAL	
		SCALE	REVISION NO:	
		NTS	00	10



ཕྱི་དབང་ལྷན་ཁག་གི་ལྷན་ཚོགས་ཀྱི་འཕུལ་སྐྱོད་ལྷན་ཁག་
 ROYAL GOVERNMENT OF BHUTAN
 DZONGKHAG ADMINISTRATION
 Ngoedrup-Tse Dzong: Chhukha
 ལྷན་ཚོགས་ཀྱི་འཕུལ་སྐྱོད་ལྷན་ཁག་



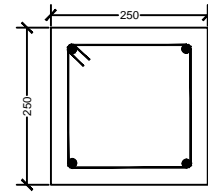

ARRANGEMENT OF 8-20Ø REBARS FOR C1 (400x400)

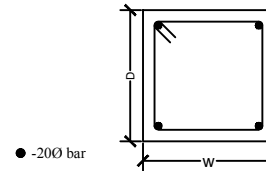

RECTANGULAR TIES DETAIL OF COLUMN

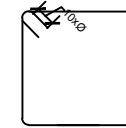

Tie details of column

Column notes:

- The section sizes provided/drawn here refers to unfinished surfaces/does not include applied finishes
- The length of column vertical rebar shall be adjusted to different lengths while erecting to ensure proper lapping in different floors except in ground/basement floor, where lapping is not allowed.
- Special confining ties of $8\text{Ø}@100\text{mm}$ c/c shall be provided over length of 'lo' from the beam face, where 'lo' is larger of $h_c/6$ or 450mm or larger of column section dimensions
- Special confining ties of $8\text{Ø}@100\text{mm}$ c/c shall be provided over the full lap length of longitudinal column rebars
- Special confining ties of $8\text{Ø}@100\text{mm}$ c/c shall be continued into the footing pad by minimum of 300mm from the top pad surface
- Columns supporting staircase shall be provided with special confining ties of $8\text{Ø}@100\text{mm}$ c/c throughout the height of the column
- One fourth(1/4) of column height of external columns shall be cast with beams/slab after necessary anchorage arrangement of beam rebar in the connecting column
- Special attention must be given for reinforcement details in footing-column joints, beam-column joints, staircase-beam joints & slabs
- The column longitudinal rebars shall not be bent/cranked without engineers prior approval
- Do not make any unspecified holes or chisels or place conduits, pipes etc. through the structural members (column, beam, etc.) without engineers prior approval.
- Except in confining zone, rest of the length of column will have stirrups of $8\text{Ø}@150\text{mm}$ c/c

Development length, $L_d \approx 57\text{Ø}$
Anchorage length, $L_a = L_d + 10\text{Ø}$

BAR DIAMETER (MM)	8	12	16	20	25
Ld (mm) FOR M20 & Fe500	456	685	915	1140	1425
La (mm) FOR M20 & Fe500	536	805	1075	1340	1675

Schedule of column

Column	Cross section, WxD	Main reinforcement bar	Special confining ties	Normal ties
C	250x250	4-20Ø	$8\text{Ø}@100\text{c/c}$	$8\text{Ø}@150\text{c/c}$

Material specifications:

- Concrete grade of M20 shall be used for all column works as per IS-456 : 2000
- Steel reinforcement grade of Fe 500 (TMT/TOR) (SQCA approved) shall be used for all RC works
- Use nominal size of aggregate of 20mm (crushed) for all RC works
- Portable water/water fit for drinking shall be used for the concrete mix & curing
- Proper curing methods shall be adopted to achieve the desired strength of concrete as per IS 456:2000
- Formworks shall not be removed until required strength of concrete is achieved.
- Minimum clear covers, footing=50mm, column=40mm, beam=25mm, slab & staircase=20 mm shall be provided.

PROJECT TITLE: Gedu Model Farm Shop	DRAWING TITLE:- As Stated	Designed/Drawn by:	Checked by:	Approved by:	NOTES:- 1. Drawings are not to be scaled of and measurements shown in drawings are to be followed. 2. Designer's responsibility shall remain limited to safe and sound structural design by this drawings and shall not be remain responsible for: a. Safety of the construction worker/any personnel at works site during construction. b. Correctness/safety of any temporary structure, scaffolding, shuttering, centering erected at site and any injury to any personnel arising out of any accident. c. Any Accident occurring due to construction elements not designed by us. d. Accident occurring due to premature de shuttering, faulty/sunstandard construction material or workmanship/faulty construction procedure. 3. All structural concrete should be weigh batched, machine mixed & mechanically vibrated. 4. Any discrepancy in the drawings should be brought to the notice of designer before construction.	DRAWING
DATE: 17.09.2019	SCALE:- NTS					STR-0

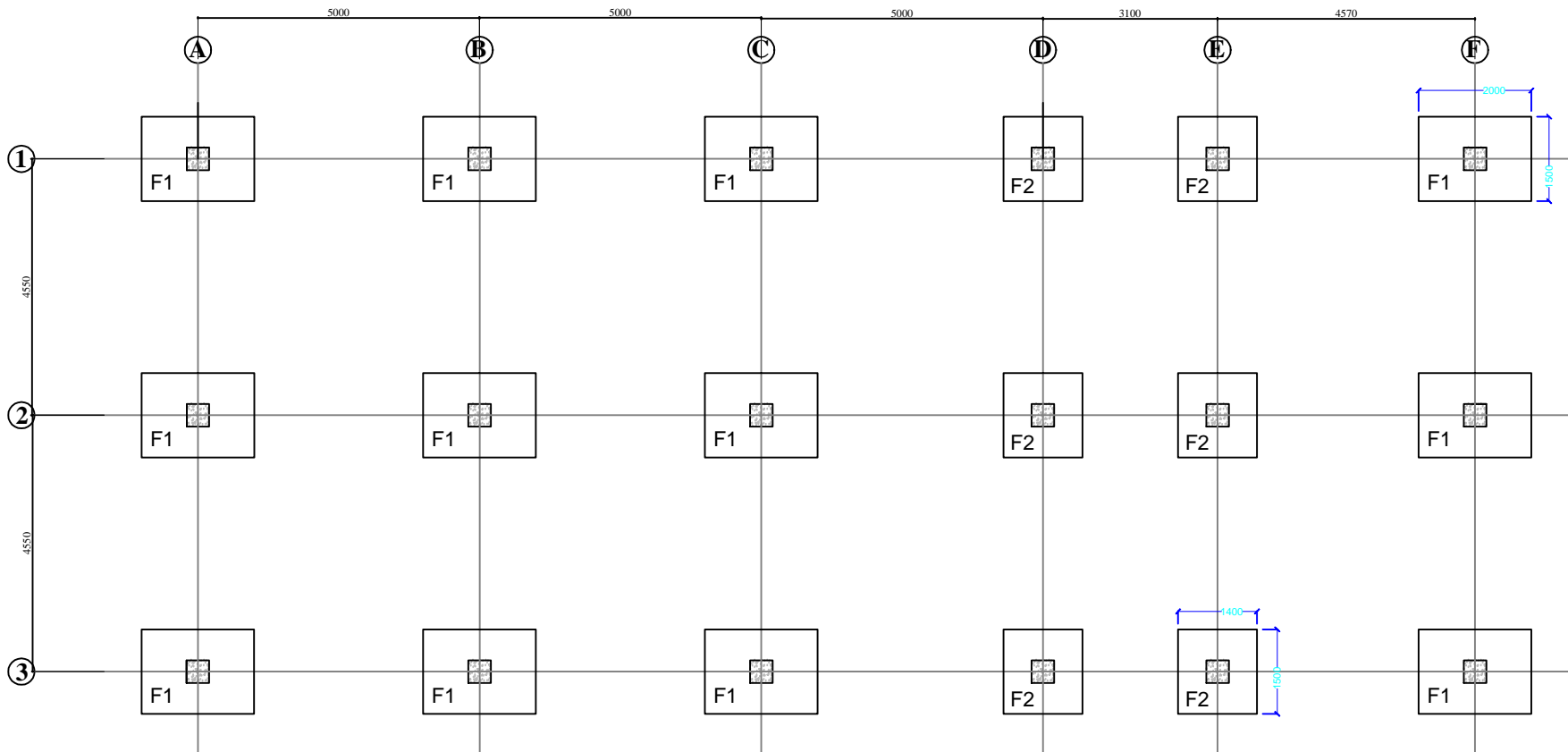

FOOTING LAYOUT PLAN

PROJECT TITLE: Gedu Model Farm Shop	DRAWING TITLE:- As Stated	Designed/Drawned by:	Checked by:	Approved by:	NOTES:- 1. Drawings are not to be scaled of and measurements shown in drawings are to be followed. 2. Designer's responsibility shall remain limited to safe and sound structural design by this drawings and shall not be remain responsible for: a. Safety of the construction worker/any personnel at works site during construction. b. Correctness/safety of any temporary structure, scaffolding, shuttering, centering erected at site and any injury to any personnel arising out of any accident.	c. Any Accident occurring due to construction elements not designed by us. d. Accident occurring due to premature de shuttering, faulty/sunstandard construction material or workmanship/faulty construction procedure. 3. All structural concrete should be weigh batched, machine mixed & mechanically vibrated. 4. Any discrepancy in the drawings should be brought to the notice of designer before construction.	DRAWING
DATE: 17.09.2019	SCALE:- NTS						STR-0

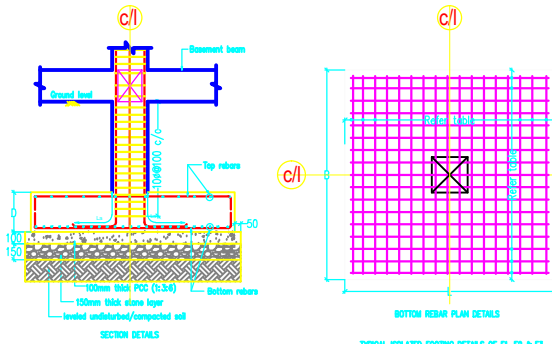

FOOTING DETAILS

TYPICAL ISOLATED FOOTING DETAILS OF F1, F2 & F3

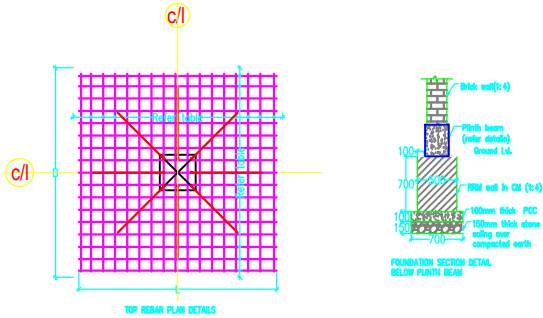

SCHEDULE OF ISOLATED FOOTINGS						
Footing	Length L	Breadth B	Total depth, D	Bottom reinforcement bar	Top reinforcement bar	Min. fdn. depth
F1	2000	1500	250	12@150 c/c in both directions	12@200 c/c in both directions	1500
F2	1500	1400	250	12@150 c/c in both directions	12@200 c/c in both directions	1500

Material specifications:

- Concrete grade of M20 shall be used for all reinforced concrete (RC) works as per IS 456:2000
- Steel reinforcement grade of Fe 500 (TMT/TOR) (SQCA approved) shall be used for all RC works
- Nominal size of aggregate of 20mm (crushed) for all RC works
- Portable water/water fit for drinking shall be used for the concrete mix & curing
- Proper curing methods shall be adopted to achieve the desired strength of concrete as per IS 456:2000

Footing notes:

- Minimum clear covering for footing pad reinforcement 50mm
- Footings are designed for an allowable safe bearing capacity of 150 kPa. Verify on the site before the commencement of the work.
- The soil/earth under the concrete footing pad shall be undisturbed soil/compacted thoroughly and a minimum of 150mm layer of course aggregate shall be placed and sealed with 100mm thick layer of binding concrete.
- If seepage/unusual soil condition is encountered during foundation excavation, consult with the designer/engineer.
- Proper shuttering shall be provided for foundation footing pads & shuttering shall be removed only after required strength of concrete is developed
- Backfill around the foundation wall shall be of selected fill and well compacted
- All the peripheral plinth beam and off-grid walls shall be provided with masonry wall foundations.

PROJECT TITLE:
Gedu Model Farm Shop

DRAWING TITLE:-
As Stated

Designed/Drawn by:
Checked by:
Approved by:

NOTES:-
1. Drawings are not to be scaled of and measurements shown in drawings are to be followed.
2. Designer's responsibility shall remain limited to safe and sound structural design by this drawings and shall not be remain responsible for:
a. Safety of the construction worker/any personnel at works site during construction.
b. Correctness/safety of any temporary structure, scaffolding, shuttering, centering erected at site and any injury to any personnel arising out of any accident.

c. Any Accident occurring due to construction elements not designed by us.
d. Accident occurring due to premature de shuttering, faulty/sunstandard construction material or workmanship/faulty construction procedure.
3. All structural concrete should be weigh batched, machine mixed & mechanically vibrated.
4. Any discrepancy in the drawings should be brought to the notice of designer before construction.

DRAWING

STR-0

DATE:
17.09.2019

SCALE:- NTS

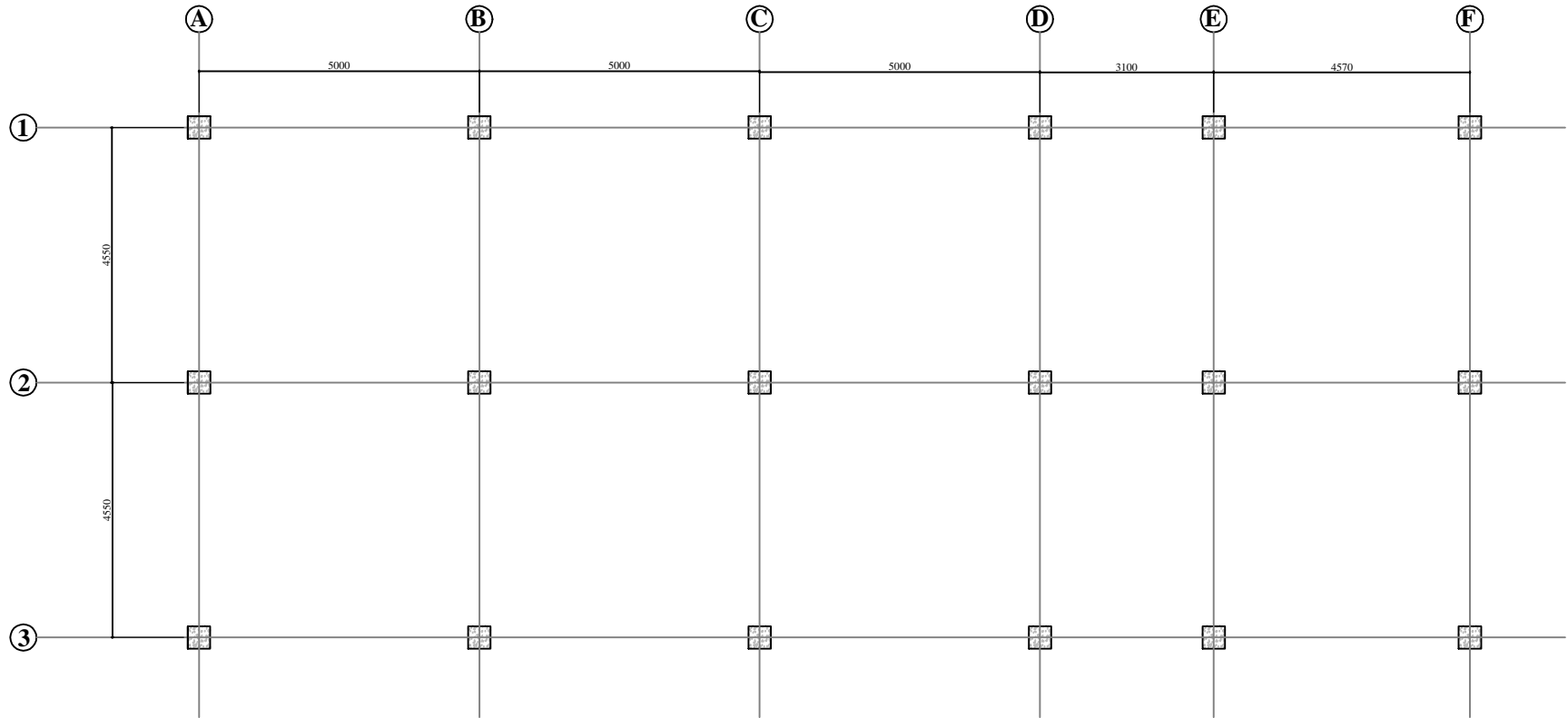

(250X250), COLUMN LAYOUT PLAN

PROJECT TITLE: Gedu Model Farm Shop	DRAWING TITLE:- As Stated	Designed/Drawned by:	Checked by:	Approved by:	NOTES:- 1. Drawings are not to be scaled of and measurements shown in drawings are to be followed. 2. Designer's responsibility shall remain limited to safe and sound structural design by this drawings and shall not be remain responsible for: a. Safety of the construction worker/any personnel at works site during construction. b. Correctness/safety of any temporary structure, scaffolding, shuttering, centering erected at site and any injury to any personnel arising out of any accident. c. Any Accident occurring due to construction elements not designed by us. d. Accident occurring due to premature de shuttering, faulty/sunstandard construction material or workmanship/faulty construction procedure. 3. All structural concrete should be weigh batched, machine mixed & mechanically vibrated. 4. Any discrepancy in the drawings should be brought to the notice of designer before construction.	DRAWING STR-0
	DATE: 17.09.2019	SCALE:- NTS				

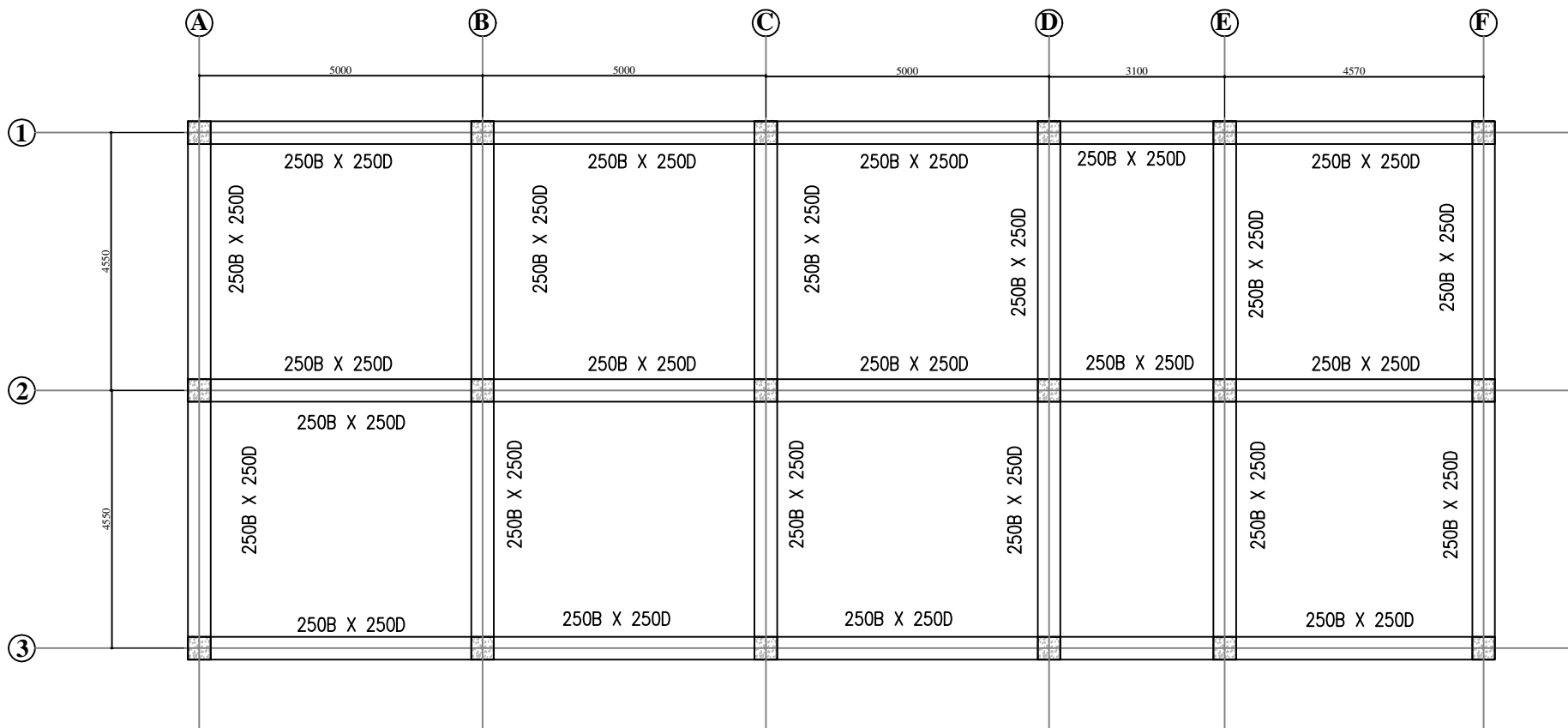

PLINTH BEAM & ROOF BEAM LAYOUT PLAN

PROJECT TITLE: Gedu Model Farm Shop	DRAWING TITLE:- As Stated	Designed/Drawn by:	Checked by:	Approved by:	NOTES:- 1. Drawings are not to be scaled of and measurements shown in drawings are to be followed. 2. Designer's responsibility shall remain limited to safe and sound structural design by this drawings and shall not be remain responsible for: a. Safety of the construction worker/any personnel at works site during construction. b. Correctness/safety of any temporary structure, scaffolding, shuttering, centering erected at site and any injury to any personnel arising out of any accident.	c. Any Accident occurring due to construction elements not designed by us. d. Accident occurring due to premature de shuttering, faulty/sunstandard construction material or workmanship/faulty construction procedure. 3. All structural concrete should be weigh batched, machine mixed & mechanically vibrated. 4. Any discrepancy in the drawings should be brought to the notice of designer before construction.	DRAWING
DATE: 17.09.2019	SCALE:- NTS						STR-0

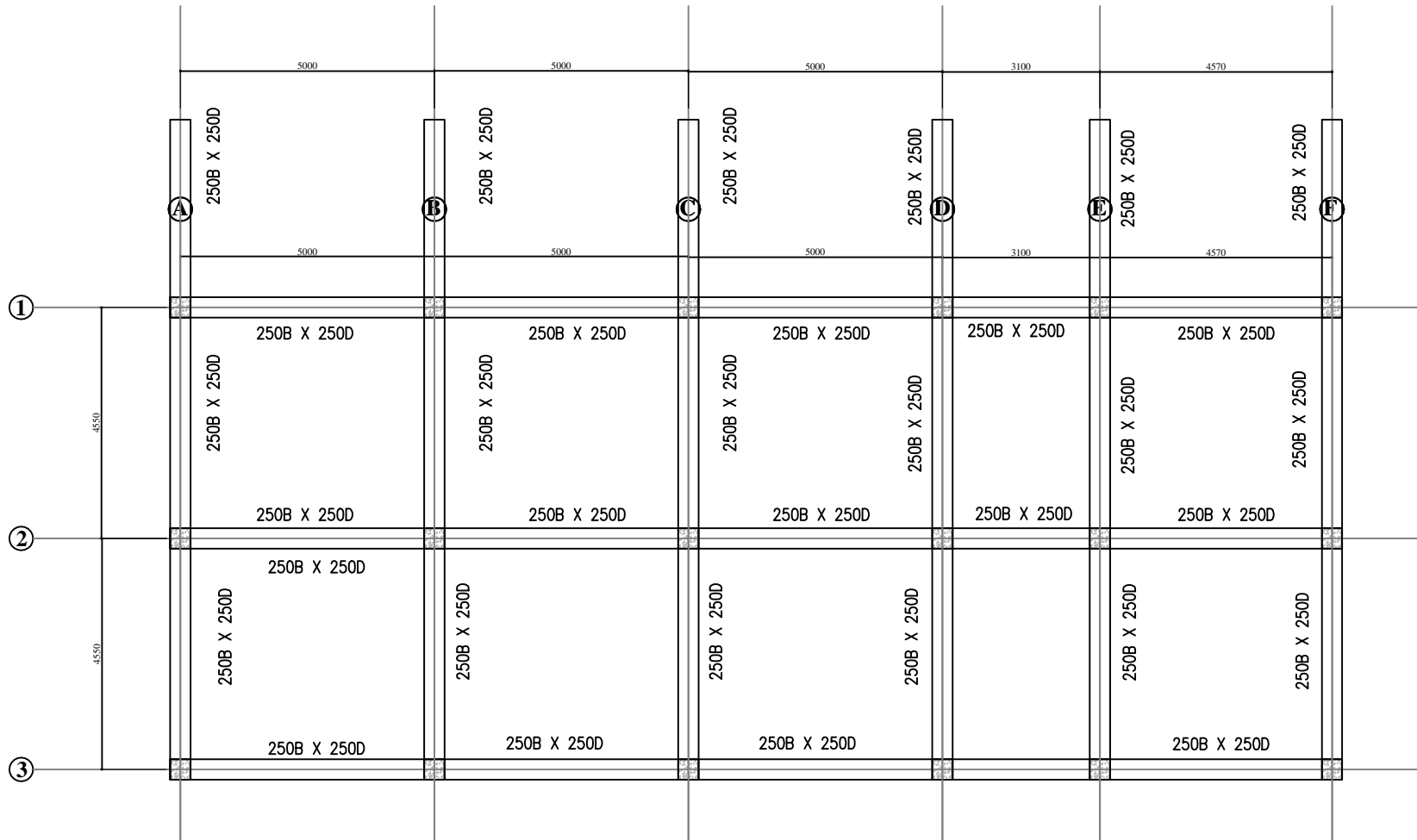

FIRST FLOOR BEAM LAYOUT PLAN

PROJECT TITLE: Gedu Model Farm Shop	DRAWING TITLE:- As Stated	Designed/Drawned by:	Checked by:	Approved by:	NOTES:- 1. Drawings are not to be scaled of and measurements shown in drawings are to be followed. 2. Designer's responsibility shall remain limited to safe and sound structural design by this drawings and shall not be remain responsible for: a. Safety of the construction worker/any personnel at works site during construction. b. Correctness/safety of any temporary structure, scaffolding, shuttering, centering erected at site and any injury to any personnel arising out of any accident. c. Any Accident occurring due to construction elements not designed by us. d. Accident occurring due to premature de shuttering, faulty/sunstandard construction material or workmanship/faulty construction procedure. 3. All structural concrete should be weigh batched, machine mixed & mechanically vibrated. 4. Any discrepancy in the drawings should be brought to the notice of designer before construction.	DRAWING STR-0
	DATE: 17.09.2019	SCALE:- NTS				

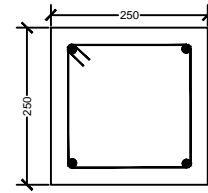

ARRANGEMENT OF 8-20Ø REBARS FOR C1 (400x400)

● -20Ø bar

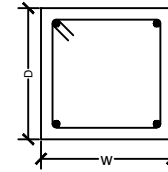

RECTANGULAR TIES DETAIL OF COLUMN

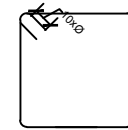

Tie details of column

Column notes:

- The section sizes provided/drawn here refers to unfinished surfaces/does not include applied finishes
- The length of column vertical rebar shall be adjusted to different lengths while erecting to ensure proper lapping in different floors except in ground/basement floor, where lapping is not allowed.
- Special confining ties of $8\text{Ø}@100\text{mm}$ c/c shall be provided over length of 'lo' from the beam face, where 'lo' is larger of $h_c/6$ or 450mm or larger of column section dimensions
- Special confining ties of $8\text{Ø}@100\text{mm}$ c/c shall be provided over the full lap length of longitudinal column rebars
- Special confining ties of $8\text{Ø}@100\text{mm}$ c/c shall be continued into the footing pad by minimum of 300mm from the top pad surface
- Columns supporting staircase shall be provided with special confining ties of $8\text{Ø}@100\text{mm}$ c/c throughout the height of the column
- One fourth(1/4) of column height of external columns shall be cast with beams/slab after necessary anchorage arrangement of beam rebar in the connecting column
- Special attention must be given for reinforcement details in footing-column joints, beam-column joints, staircase-beam joints & slabs
- The column longitudinal rebars shall not be bent/cranked without engineers prior approval
- Do not make any unspecified holes or chisels or place conduits, pipes etc. through the structural members (column, beam, etc.) without engineers prior approval.
- Except in confining zone, rest of the length of column will have stirrups of $8\text{Ø}@150\text{mm}$ c/c

Development length, $L_d \approx 57\text{Ø}$
Anchorage length, $L_a = L_d + 10\text{Ø}$

BAR DIAMETER (MM)	8	12	16	20	25
Ld (mm) FOR M20 & Fe500	456	685	915	1140	1425
La (mm) FOR M20 & Fe500	536	805	1075	1340	1675

Schedule of column

Column	Cross section, WxD	Main reinforcement bar	Special confining ties	Normal ties
C	250x250	4-20Ø	$8\text{Ø}@100\text{c/c}$	$8\text{Ø}@150\text{c/c}$

Material specifications:

- Concrete grade of M20 shall be used for all column works as per IS-456 : 2000
- Steel reinforcement grade of Fe 500 (TMT/TOR) (SQCA approved) shall be used for all RC works
- Use nominal size of aggregate of 20mm (crushed) for all RC works
- Portable water/water fit for drinking shall be used for the concrete mix & curing
- Proper curing methods shall be adopted to achieve the desired strength of concrete as per IS 456:2000
- Formworks shall not be removed until required strength of concrete is achieved.
- Minimum clear covers, footing=50mm, column=40mm, beam=25mm, slab & staircase=20 mm shall be provided.

PROJECT TITLE: Gedu Model Farm Shop	DRAWING TITLE:- As Stated	Designed/Drawn by:	Checked by:	Approved by:	NOTES:- 1. Drawings are not to be scaled of and measurements shown in drawings are to be followed. 2. Designer's responsibility shall remain limited to safe and sound structural design by this drawings and shall not be remain responsible for: a. Safety of the construction worker/any personnel at works site during construction. b. Correctness/safety of any temporary structure, scaffolding, shuttering, centering erected at site and any injury to any personnel arising out of any accident. c. Any Accident occurring due to construction elements not designed by us. d. Accident occurring due to premature de shuttering, faulty/sunstandard construction material or workmanship/faulty construction procedure. 3. All structural concrete should be weigh batched, machine mixed & mechanically vibrated. 4. Any discrepancy in the drawings should be brought to the notice of designer before construction.	DRAWING
DATE: 17.09.2019	SCALE:- NTS					STR-0

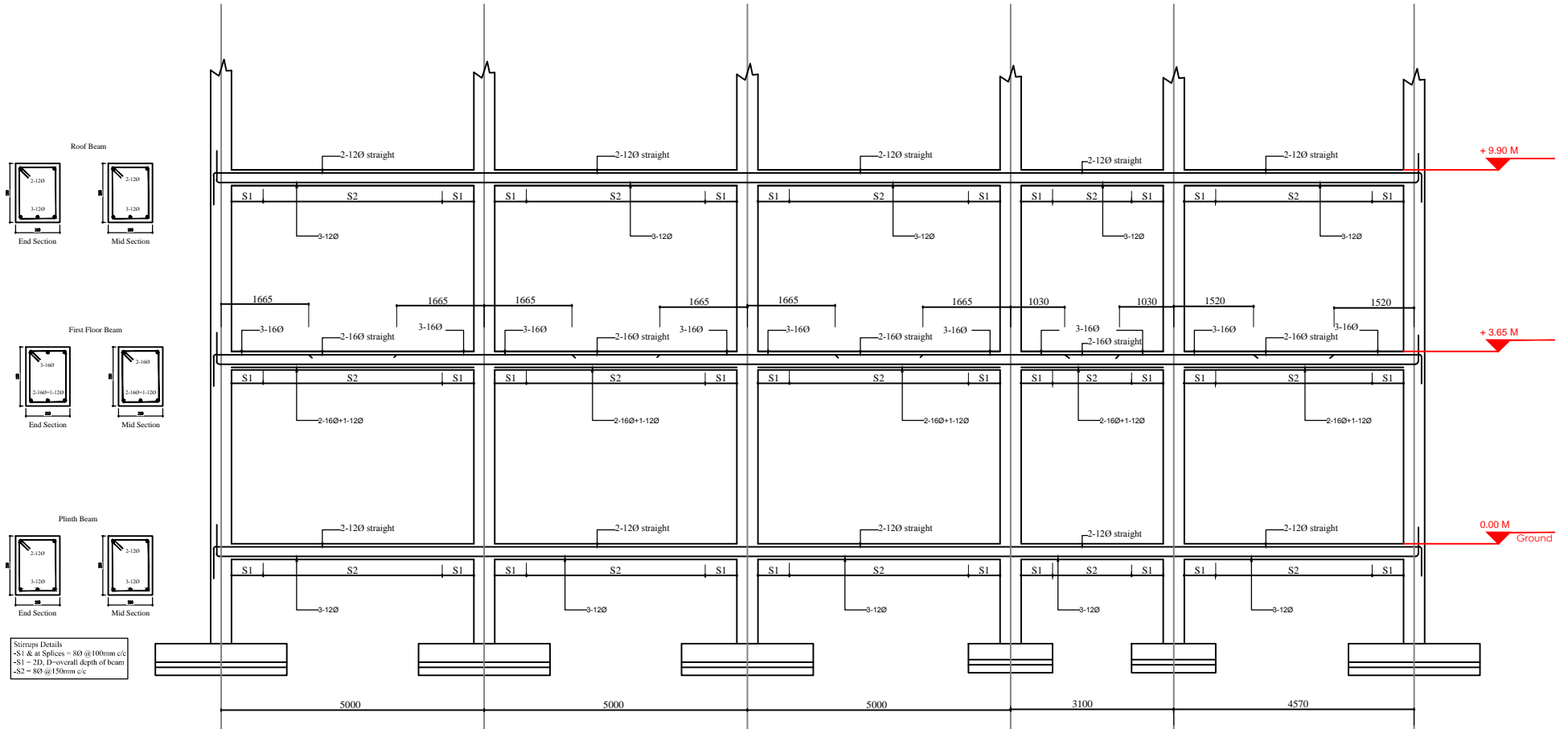

BEAM ALONG GRID - 1, 2, 3 (1st, 2nd & ROOF FLOOR)

PROJECT TITLE: Gedu Model Farm Shop	DRAWING TITLE:- As Stated	Designed/Drawn by:	Checked by:	Approved by:	NOTES:- 1. Drawings are not to be scaled and measurements shown in drawings are to be followed. 2. Designer's responsibility shall remain limited to safe and sound structural design by this drawings and shall not be remain responsible for: a. Safety of the construction worker/any personnel at works site during construction. b. Correctness/safety of any temporary structure, scaffolding, shuttering, centering erected at site and any injury to any personnel arising out of any accident. c. Any Accident occurring due to construction elements not designed by us. d. Accident occurring due to premature de shuttering, faulty/sunstandard construction material or workmanship/faulty construction procedure. 3. All structural concrete should be weigh batched, machine mixed & mechanically vibrated. 4. Any discrepancy in the drawings should be brought to the notice of designer before construction.	DRAWING
	DATE: 17.09.2019	SCALE:- NTS				

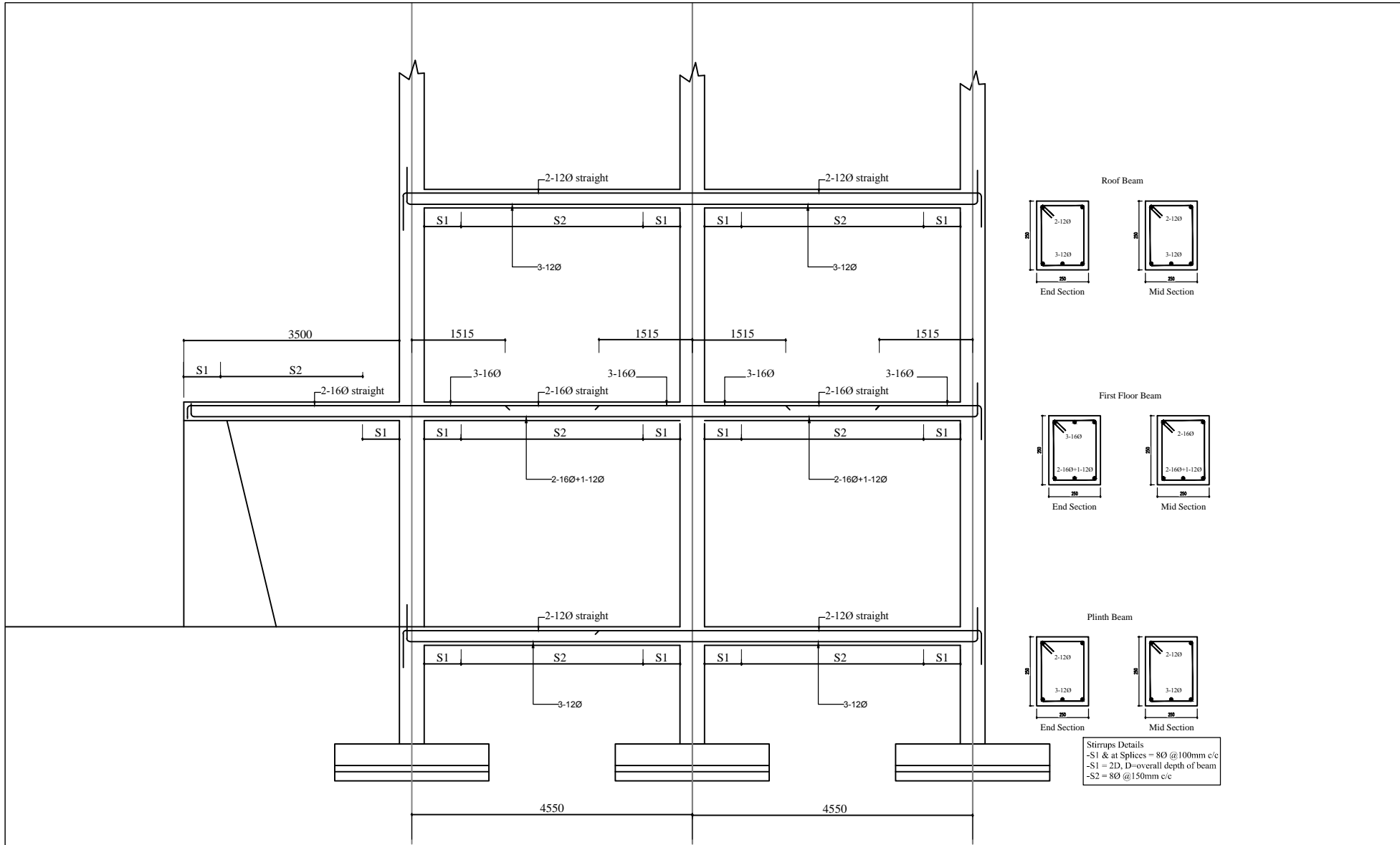

BEAM ALONG GRID - A,B,C,D,E,F (1st, 2nd & ROOF FLOOR)

PROJECT TITLE: Gedu Model Farm Shop	DRAWING TITLE:- As Stated	Designed/Drawn by:	Checked by:	Approved by:	NOTES:- 1. Drawings are not to be scaled and measurements shown in drawings are to be followed. 2. Designer's responsibility shall remain limited to safe and sound structural design by this drawings and shall not be remain responsible for: a. Safety of the construction worker/any personnel at works site during construction. b. Correctness/safety of any temporary structure, scaffolding, shuttering, centering erected at site and any injury to any personnel arising out of any accident.	c. Any Accident occurring due to construction elements not designed by us. d. Accident occurring due to premature de shuttering, faulty/sunstandard construction material or workmanship/faulty construction procedure. 3. All structural concrete should be weigh batched, machine mixed & mechanically vibrated. 4. Any discrepancy in the drawings should be brought to the notice of designer before construction.	DRAWING STR-0
DATE: 17.09.2019	SCALE:- NTS						

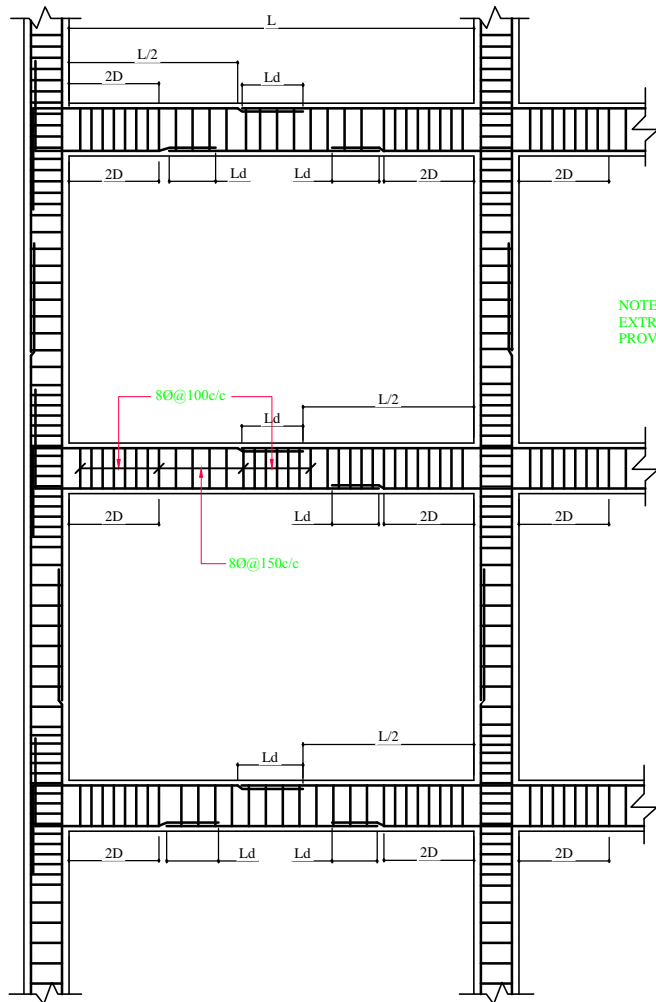

TYPICAL ARRANGEMENT OF STIRRUPS & SPLICES IN BEAMS

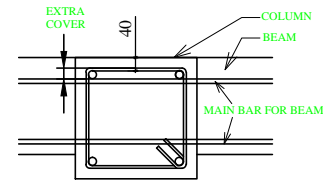

DETAILS FOR EXTRA COVER TO BEAMS

NOTE:
EXTRA COVER SHALL BE PROVIDED TO THE BEAMS WITH THE PROVISION OF WALLS FLUSHING WITH THE COLUMNS

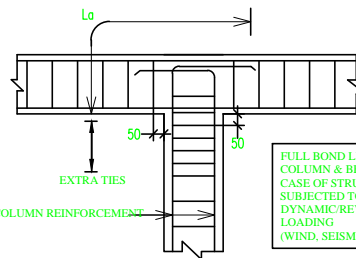

COLUMN TERMINATION DETAILS IN BEAM (ELEVATION)

FULL BOND LENGTH FOR COLUMN & BEAM BARS IN CASE OF STRUCTURES SUBJECTED TO DYNAMIC/REVERSIBLE LOADING (WIND, SEISMIC ETC)

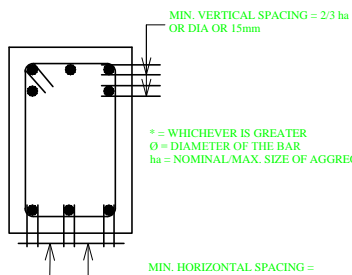

TYPICAL DETAILS FOR MINIMUM CLEARANCE BETWEEN INDIVIDUAL BARS

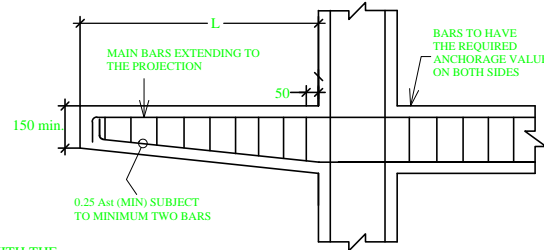

TYPICAL CANTILEVER BEAM DETAILS PROJECTING FROM BEAM OR COLUMN

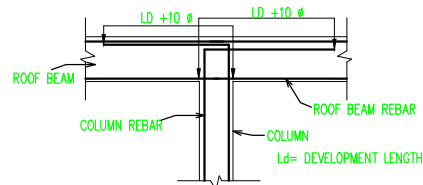

COLUMN REBARS ANCHORAGE DETAILS AT THE ROOF

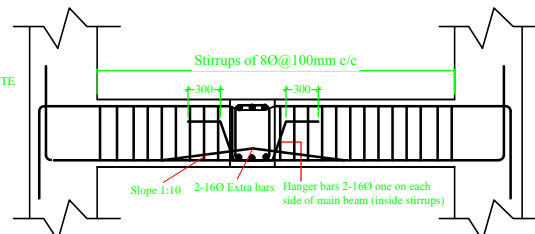

PRIMARY AND SECONDARY BEAM CONNECTION DETAILS

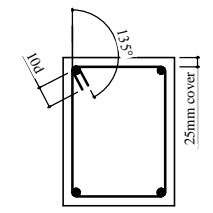

TYPICAL BEAM STIRRUPS DETAILS

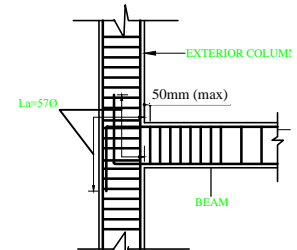

EXTERIOR BEAM-COLUMN JUNCTION DETAIL

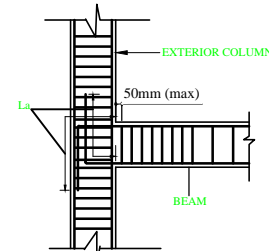

TYPICAL BEAM BAR ANCHORAGE DETAIL

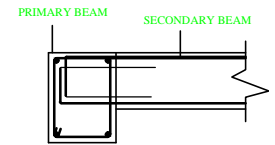

PRIMARY AND SECONDARY BEAM JUNCTION DETAILS

PROJECT TITLE: Gedu Model Farm Shop	DRAWING TITLE:- As Stated	Designed/Drawn by:	Checked by:	Approved by:	NOTES:- 1. Drawings are not to be scaled and measurements shown in drawings are to be followed. 2. Designer's responsibility shall remain limited to safe and sound structural design by this drawings and shall not be remain responsible for: a. Safety of the construction worker/any personnel at works site during construction. b. Correctness/safety of any temporary structure, scaffolding, shuttering, centering erected at site and any injury to any personnel arising out of any accident. c. Any Accident occurring due to construction elements not designed by us. d. Accident occurring due to premature de shuttering, faulty/sunstandard construction material or workmanship/faulty construction procedure. 3. All structural concrete should be weigh batched, machine mixed & mechanically vibrated. 4. Any discrepancy in the drawings should be brought to the notice of designer before construction.	DRAWING
DATE: 17.09.2019	SCALE:- NTS					STR-0